



**RX-7490**

**ERGO™ Precision Flat Nose  
Stubby Pliers with Dual-  
Component Synthetic Handle**





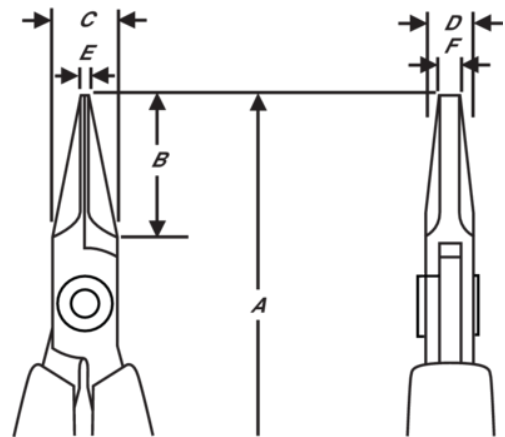

**PRODUCT DETAILS**

- Two-component Ergo™ handles: Thermoplastic surface on tough polypropylene provides superior grip
- Material: High performance alloy steel
- Polished and tough hardened 55-58 HRC
- Precision screw joint that minimizes friction and maximizes alignment of cutting edges
- Micro-Touch™: The shape of the handles makes it possible to control and rotate the pliers between thumb and index finger for precision work
- Biospring® reduces tension throughout the working cycle of the tool and can be adjusted in three different positions
- Burnished finish







## PRODUCT ATTRIBUTES





### Product: **RX7390**

	Flat Nose Stubby		S	<b>A</b>	137 mm
<b>A</b>	5.40 in	<b>B</b>	11 mm	<b>B</b>	0.43 in
<b>C</b>	10 mm	<b>C</b>	0.39 in	<b>D</b>	6 mm
<b>D</b>	0.24 inch	<b>E</b>	6 mm	<b>E</b>	0.24 in
<b>F</b>	0.8 mm	<b>F</b>	0.07 in		Smooth
		<b>Ω</b>	Dissipative		

### Product: **RX7392**

	Oblique, Stubby		S	<b>A</b>	137 mm
<b>A</b>	5.40 in	<b>B</b>	12 mm	<b>B</b>	0.48 in
<b>C</b>	10 mm	<b>C</b>	0.39 in	<b>D</b>	6 mm
<b>D</b>	0.24 inch	<b>E</b>	6 mm	<b>E</b>	0.24 in
<b>F</b>	1.6 mm	<b>F</b>	0.07 in		Smooth
	70 g	<b>Ω</b>	Dissipative		

### Product: **RX-7490**

	Flat Nose		S	<b>A</b>	146.5 mm
<b>A</b>	5.77 in	<b>B</b>	20 mm	<b>B</b>	0.79 in
<b>C</b>	9 mm	<b>C</b>	0.35 in	<b>D</b>	6.7 mm
<b>D</b>	0.26 inch	<b>E</b>	1.2 mm	<b>E</b>	0.05 in
<b>F</b>	3.2 mm	<b>F</b>	0.12 in		Smooth
	70 g	<b>Ω</b>	Dissipative		