

This product is completed the Lead-free & RoHS2.0 & Halogen-free.

Customer : Ozdisan

Issued Date	2024-8-30
No.	RD20240830007

SPECIFICATION FOR APPROVAL

No.	Customer No.	Koshin Part No.	Description	ΦD x L
1		PKLF-035V101ME110-T2.5	35V100μF	6.3X11



KOSHIN INTERNATIONAL LIMITED

Headquarters

Unit 9-10,16/F,New commerce Centre,19 On Sun Street,Siu Lek Yuen,Shatin,N.T.,Hong kong
TEL: (852) 2690 0609 FAX: (852) 2697 9532

Manufacturing Sites

- No.4-6 West Zone,Shangxue Technology Industrial City,Bantian,Longgang,Shenzhen,China
TEL: +86-0755-89500370 89500371 FAX: +86-0755-89500348
- Koshin Technology Industrial Zone South Huancheng Road,LinWu,Chenzhou,Hunan
Provice,China
TEL: +86-0735-7770828 Postal code:424300

KOSHIN APPROVED SIGNATURE FOR KOSHIN			APPROVED SIGNATURE FOR CUSTOMER
APPROVAL	CHECK	DESIGN	APPROVED BY
			

Please return one copy with your authorized signature when you accept these specifications.

DJS-SD-0013

CONTENTS

NO.	ITEM
1	Scope
2	Operating Temperature Range
3	Characteristics
4	Frequency Coefficient for Ripple Current
5	Coefficient of Temperature for Ripple Current
6	Max. Impedance Ratio
7	Characteristics Table
8	Marking
9	Inner conformation drawing and inner constitute parts(curtness drawing)
10	Electrical characteristics
11	Mechanical characteristics
12	Reliability
13	Koshin Part No
14	Product processing diagram
15	Packing
16	Guidelines and Precautions

1.Scope

This specification covers "KLF series" miniature single-ended aluminium electrolytic capacitors.

2.Operating Temperature Range

Operating temperature range is the range of ambient temperature at which the capacitor can be operated continuously at rated voltage.

3.Characteristics

Unless otherwise specified, the standard range of atmospheric conditions for making measurements and tests are as follows.

Ambient temperature : 15 to 35°C

大气力压 Air pressure: 86kpa to 106kpa

If there may be doubt on the results, measurements shall be made within the following limits.

Ambient temperature : 20±2°C

大气压 Air pressure: 86kpa to 106kpa

4.Frequency Coefficient for Ripple Current

Frequency (Hz)	120	1K	10K	100K
Coefficient	0.50	0.80	0.85	1.00

5.Coefficient of Temperature for Ripple Current

Temperature(°C)	60 or less	85	105
Coefficient	2.00	1.40	1.00

NOTE:Temperature coefficient is not used in life formula but for reference.

6.Max. Impedance Ratio

Low temperature characteristics	Rated voltage(V)		10	16	25	35	50	160-250	350-450	120Hz
	Impedance ratio (max)	$Z_{(-25^{\circ}\text{C})} / Z_{(+20^{\circ}\text{C})}$	4	3	2	2	2	3	6	

7 Characteristics Table

Aluminum Electrolytic Capacitor Specification				
Series	PKLF	35 V 100 μ F	Part No.	PKLF-035V101ME110-T2.5
Customer No.			Case size	Φ D 6.3 X L 11
Specification	Items		Standard	
	Operating temperature range		- 40~ + 105 $^{\circ}$ C	
	Capacitance tolerance		\pm 20% (20 $^{\circ}$ C ,120Hz)	
	Dissipation factor (MAX)		小于(Less than) 12% (20 $^{\circ}$ C ,120Hz)	
	Leakage current (MAX)		小于(Less than) 35 μ A (20 $^{\circ}$ C35V 2min)	
	ESR(MAX)		0.098 Ω (100KHz ,20 $^{\circ}$ C)	
	Ripple current (MAX)		545mArms (100KHz ,105 $^{\circ}$ C)	
	Load life		8000 hrs	
Outline	Dimensions			
	Copper clad steel wire(tinned)			
APPROVAL		CHECK		DESIGN

8. Marking

8.1 Marking on capacitors include:

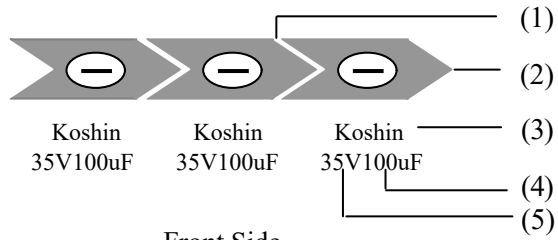

Front Side

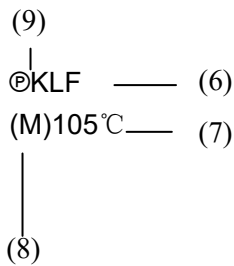

Back Side

NO.	ITEM
1	direction of current
2	Polarity
3	Brand
4	Capacity
5	Voltage
6	Series
7	Temp
8	Tolerance
9	⊗ / Sleeve material (PET)

8.2 Marking color :

Sleeve color: Black Blue PET

Marking color: White

9.Inner conformation drawing and inner constitute parts(curtness drawing)

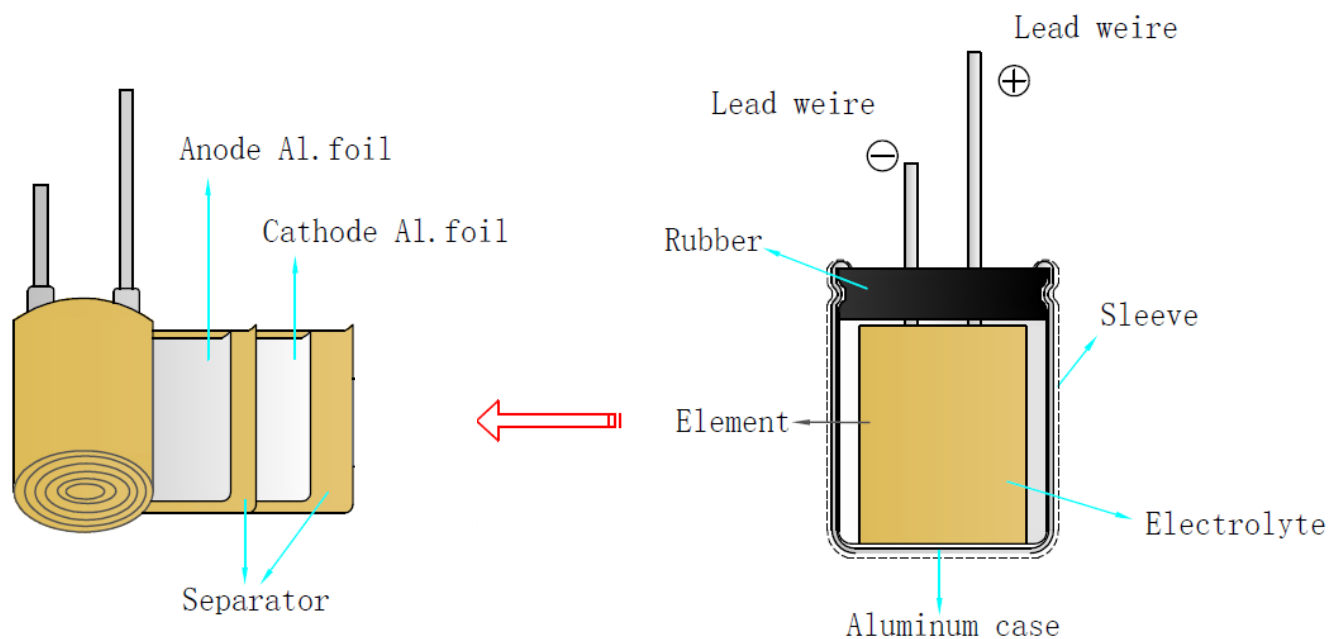

Composing Parts	Material
Anode Foil	Aluminum Foil
Cathode Foil	Aluminum Foil
Paper	Cellulose
Lead Wire	Fe+Al+Cu+Sn
Lead Wire	Fe+Al+Cu+Sn
Seal	Rubber
Case	Aluminum
Sleeve	PET
Electrolyte	EG

NO.	ITEM	TEST METHOD	SPECIFICATION																				
10.6	Surge test	<p>Rated surge voltage shall be applied (switch on)for 30±5 second and then shall be applied (switch off) with discharge for 5.5min at room temperature. This cycle shall be repeated for 1000 cycles. Duration of one cycle is 6±0.5 minutes</p> <p>Surge voltage</p> <table border="1"> <tr> <td>Working voltage(V) 工作电压(V)</td> <td>6.3</td> <td>10</td> <td>16</td> <td>25</td> <td>35</td> <td>50</td> <td>63</td> <td>80</td> <td>100</td> </tr> <tr> <td>Surge voltage (V) 浪涌电压(V)</td> <td>8</td> <td>13</td> <td>20</td> <td>32</td> <td>44</td> <td>63</td> <td>79</td> <td>100</td> <td>125</td> </tr> </table>	Working voltage(V) 工作电压(V)	6.3	10	16	25	35	50	63	80	100	Surge voltage (V) 浪涌电压(V)	8	13	20	32	44	63	79	100	125	<p>Capacitance change: within±15% of the initial specified value.</p> <p>Dissipation factor: Less than specified value.</p> <p>Leakage current: Within initial specified value.</p>
Working voltage(V) 工作电压(V)	6.3	10	16	25	35	50	63	80	100														
Surge voltage (V) 浪涌电压(V)	8	13	20	32	44	63	79	100	125														

11.Mechanical characteristics:

NO.	ITEM	TEST METHOD	SPECIFICATION																
11.1	Lead strength	<p>(A)Tensile strength: wire lead terminal:</p> <table border="1"> <tr> <td>d(mm)</td> <td>≤0.5</td> <td>0.5<d≤0.8</td> <td>0.8<d≤1.25</td> </tr> <tr> <td>load(kg)</td> <td>0.5</td> <td>1.0</td> <td>2.0</td> </tr> </table> <p>The capacitor shall withstand the constant tensile force specified between the body and each lead for 10seconds without damage either mechanical or electrical.</p> <p>(B) Bending strength: wire lead terminal:</p> <table border="1"> <tr> <td>d(mm)</td> <td>≤0.5</td> <td>0.5<d≤0.8</td> <td>0.8<d≤1.25</td> </tr> <tr> <td>load(kg)</td> <td>0.5</td> <td>0.5</td> <td>1.0</td> </tr> </table> <p>with the capacitor in a vertical position apply the load specified axially to each lead. The capacitor shall be rotated slowly from the vertical to the horizontal position, back to the vertical position. The 90° in the opposite direction and back the original position. Performance of capacitor shall not have change and leads shall be undamaged.</p>	d(mm)	≤0.5	0.5<d≤0.8	0.8<d≤1.25	load(kg)	0.5	1.0	2.0	d(mm)	≤0.5	0.5<d≤0.8	0.8<d≤1.25	load(kg)	0.5	0.5	1.0	<p>When the capacitance is measured, there shall be no intermittent contacts, or open-or short-circuiting.</p> <p>There shall be no such mechanical damage as terminal damage etc.</p>
d(mm)	≤0.5	0.5<d≤0.8	0.8<d≤1.25																
load(kg)	0.5	1.0	2.0																
d(mm)	≤0.5	0.5<d≤0.8	0.8<d≤1.25																
load(kg)	0.5	0.5	1.0																

NO.	ITEM	TEST METHOD	SPECIFICATION
11.2	Vibration resistance	The frequency of the vibration shall vary uniformly within the range 10 to 55 Hz with the amplitude of 0.75mm, completing the cycle in the interval of one minute. The capacitor shall be securely mounted by its leads with hold the body of capacitor. The capacitor shall be vibrated in three mutually perpendicular directions for a period of 2 hours in each direction.	Capacitance: no unsteady. Appearance: no abnormal. Capacitance change: within $\pm 5\%$ of initial measured value.
11.3	Solder-ability	The leads are dipped in the solder bath of Sn at $245^{\circ}\text{C}\pm 5^{\circ}\text{C}$ for 2 ± 0.5 seconds. The dipping depth should be set at 1.5~2.0 mm.	The solder alloy shall cover the 95% or more of dipped lead's area.

12. Reliability:

NO.	ITEM	TEST METHOD	SPECIFICATION
12.1	Soldering heat resistance	The leads immerse in the solder bath of Sn at $260^{\circ}\text{C}\pm 5^{\circ}\text{C}$ for 10 ± 1 seconds until a distance of 1.5~2.0mm from the case.	No visible damage or leakage of electrolyte. Capacitance change: Within $\pm 5\%$ of the initial measured value Tan δ : Less than specified value. Leakage current: Less than specified value
12.2	Moisture Resistance	Subject the capacitor to $40^{\circ}\text{C} \pm 2^{\circ}\text{C}$ and 90% to 95% relative humidity for 504 hours.	Capacitance change: Within $\pm 20\%$ of the initial measured value Tan δ : Less than 1.2 specified value. Leakage current: Less than specified value

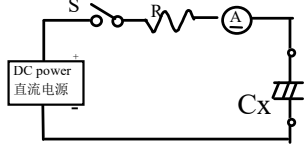
NO.	ITEM	TEST METHOD	SPECIFICATION
12.3	Load life	After 8000 hours continuous application of DC rated working voltage and rated ripple current at $105^{\circ}\text{C} \pm 2^{\circ}\text{C}$, Measurements shall be performed after 16 hours exposed at room temperature.	Capacitance change: within $\pm 20\%$ of the initial specified value. Dissipation factor: Less than 200% of the initial specified value.
12.4	Shelf life	After storage for 1000 hours at $105^{\circ}\text{C} \pm 2^{\circ}\text{C}$ without voltage application, Measurements shall be performed after exposed for 16 hrs at room temperature after application of Testing	Leakage current: Within initial specified value.
12.5	Storage at low temperature	The capacitor shall be stored at temperature of $-40^{\circ}\text{C} \pm 3^{\circ}\text{C}$ for 16 hours, during which time be subjected to standard atmospheric conditions for 16 hours or more. After which measurements shall be made.	Capacitance change: Within $\pm 10\%$ of the initial value. Tan δ :less than specified value Leakage current: Less than specified value. Appearance :no Abnormal.
12.6	Pressure relief	DC test Send the following electricity while applying the inverse voltage. Where case size(外壳尺寸(D 直径)) $D \leq 22.4\text{mm}$: 1 A d.c.max $D > 22.4\text{mm}$: 10 A d.c.max Note: 1.This requirement applies to capacitors with a diameter of 6 mm or more. 2. When the pressure relief device does not open even 30 minutes after commencement of test, the test may be ended.	DC test circuit  S : Switch Ⓐ : DC current meter Cx: testing capacitor The pressure relief device shall open in such a way as to avoid any damage of fire or explosion of capacitor elements (terminal and metal foil etc.) or cover.

13.Koshin Part No

Part Number System

PKLF-035V 101 M E 110-T2.5

① ② ③ ④ ⑤ ⑥ ⑦

(1) Series

KC3	K3S	K3N	KCL	KR2	KRJ	KRN	KLS	KZL	KSH	KSJ	KLJ	KR1	KLP	KRM	KHP	KAG	KZM	KHT	KRB	KZB
KBP	KRL	KLL	KJH	KLH	KZH	KCH	KZF	KRH	KLF	KLG	KLW	KLE	KRF	K2A	K3A	KA3	KBD			

(2) Voltage(WV)

Voltage(WV)	4	6.3	10	16	25	35	50	63	80	100	110	115
Code	004	6R3	010	016	025	035	050	063	080	100	110	115

Voltage(WV)	125	160	165	200	220	250	330	350	400	450	500	550
Code	125	160	165	200	220	250	330	350	400	450	500	550

(3) Capacitance

Capacitance is show in microfarads (μF)

μF	0.1	0.47	1	2.2	22	220	2200	22000	21~25(KLT)
Code	0R1	R47	010	2R2	220	221	222	223	21T25

(4) Capacitance tolerance

Tolerance %	± 5	± 10	± 15	± 20	-0 to +100	-0 to +20	-10 to +20	-10 to +100
Code	J	K	L	M	P	R	V	W

Tolerance %	-15 to +20	-20 to +40	-20 to +80	-20 to +5	+5 to +20	-10 to +5	-30 to +20	-15 to +5
Code	N	X	E	A	B	C	D	F

(5) Case (D: mm)

Diameter	3	4	5	6	6.3	7	8	10	12.5	13	16	18	20	22	25	30	34
Code	A	B	C	D	E	1E	F	G	H	I	J	K	L	M	N	O	P

Diameter	35	36.5	40	42	45	46	50	51	52.3	55	60	63.5	65.5	76	90	100
Code	Q	R	S	T	U	V	W	X	Y	Z	1A	1B	1C	1D	1E	1F

Part Number System

(6) Case (L: mm)

Description	5	7	11	12.5	25	35.5	40	100	110	111	120	130	140	150	220	250
Code	050	070	110	125	250	355	400	A00	A10	A11	A20	A30	A40	A50	B20	B50

(7) Lead treatment

Description	Taping(F:2.5mm) Ammo Packing	Taping(F:3.5mm) Ammo Packing	Taping(F:5.0mm) Ammo Packing	Taping(F7.5mm) Ammo Packing
Code	T2.5(T/A2.5)	T/A3.5	T/A5.0(S)	T/A7.5

Description	Lead cut		Lead forming cut			Lead forming cut	Lead forming cut	Frog forming cut
	F10	L/C	F4	F12	F/C	S1	F/S	F/W

Note: PET sleeve capacitors adding "P" in Part No. System before.

14. Product processing diagram:

Taping size $\Phi 6.3$

TP2.5mm pitch tape packing

Taping code number: T2.5

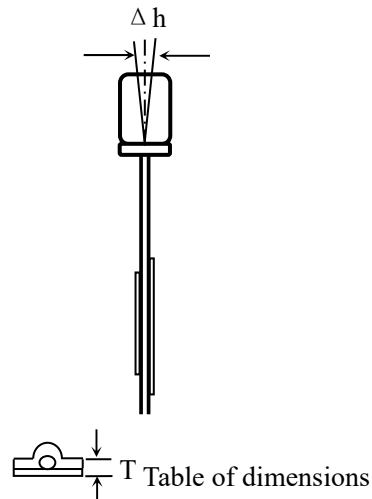
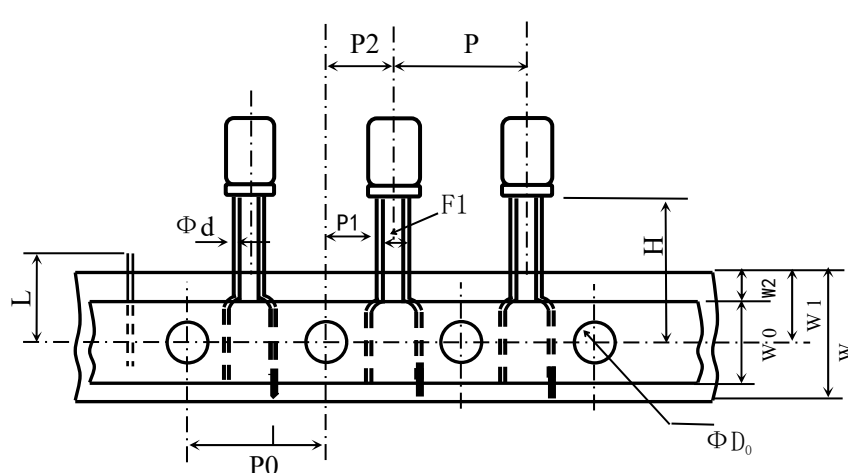

Item	Symbol	Dimension	Tolerance	Reference
Lead-wire diameter	Φd	0.5	± 0.05	
Distance between centers of leads	F1	2.5	± 0.5	
Height of component form tape center	H	18.5	+0.75 -0.5	
Component spacing	P	12.7	± 1.0	
Perforation pitch	P0	12.7	± 0.3	
Hole center to lead distance	P1	4.6	± 0.5	
Hole center to component center	P2	6.35	± 1.0	
Carrier tape width	W	18.0	± 0.5	
Hole down tape width	W0	6.0~13.0	± 0.1	
Feed hole position	W1	9.0	± 0.5	
Hole down tape width	W2	0.5-1.5	-----	
Diameter of sprocket holes	$\Phi D0$	4.0	± 0.2	
Body inclination forward or backward	Δh	0	± 1.0	
Tape base thickness	t0	0.38	± 0.05	
Total thickness of the combined carrier tape and hold down tape	T	0.6	± 0.3	
Cut off position of defectives	L	11.0	or less	

15. Packing

Packing Standards: standards of the carton

1. Standards of the inner box of tapping products.

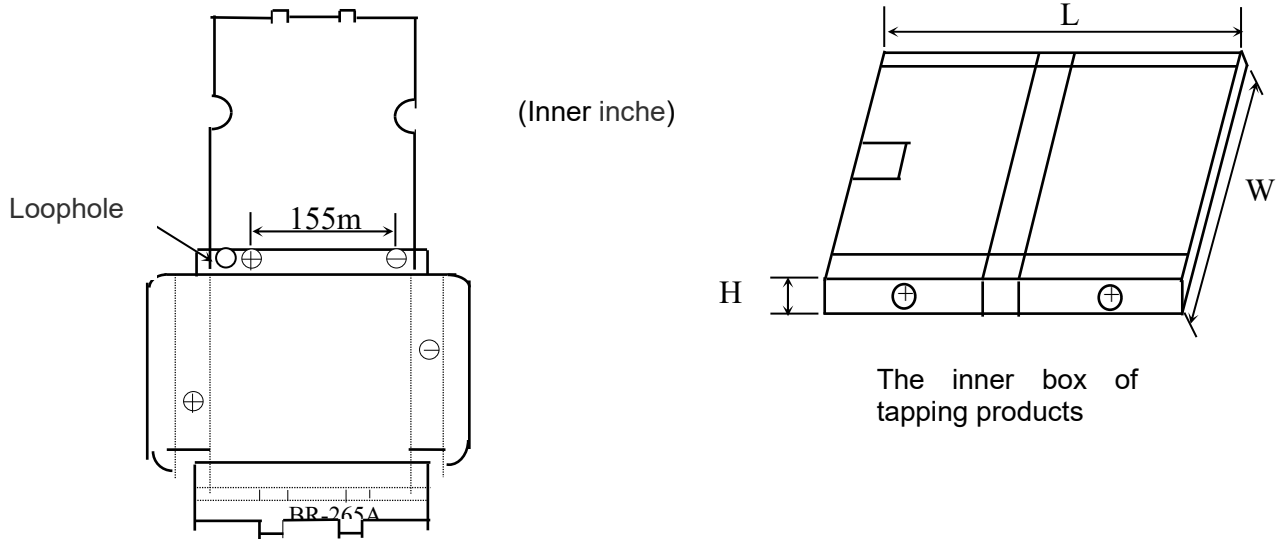

Specification	Size ± 2 (mm) L×W×H	Packing form	Textures	Quantity(PCS)
BR-285B	290X330X45	Tapping and boxed	A3A	2000

2. Standards of the outer box of bulk and tapping products.

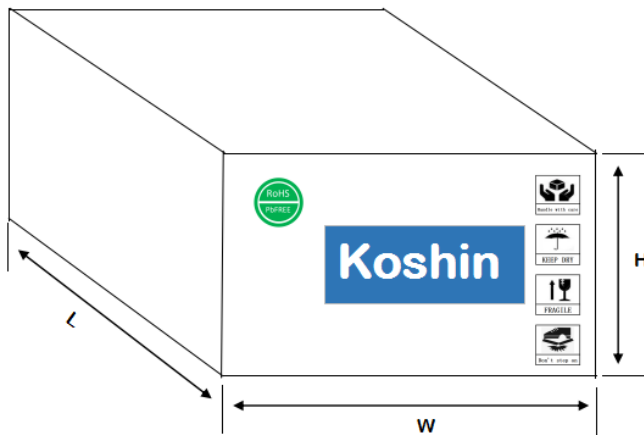

Specification	Size ± 2 (mm) L×W×H	Packing form	Textures	Quantity(PCS)
BW-610A	610X348X285	Tapping	K=K	20K

3.Label:

series	Size(mm)	Sample
Label	90×40	As the right

Koshin Electrolytic Capacitors			
OPN:	××××		
Type:	③	Qty: ⑧ pcs	KS2020011302480
CPN:	⑤⑥⑦	Work order number: ②	
	④		
	①		

- ①Customer name
- ②Work order number Lot NO.
- ③Koshin Part No.
- ④ Customer Part No.
- ⑤Series
- ⑥Voltage
- ⑦Capacity
- ⑧Size
- ⑨Quantity

②“制造传票”上的编号 Lot NO. :

“制造传票”上的编号 Lot NO. 编码原则为：产品类型+“-”+年份+月份+日期+工单流水号+“-”+制造传票流水号

- 1、产品类型：2511 液态产品，2513 固态产品，2515 SMD 产品
- 2、年份由 2 位数组成，例：2022 年用“22”表示，2023 年用“23”表示，依此类推。
- 3、月份由 2 位数组成，例：1 月份用“01”表示，2 月份用“02”表示，依此类推。
- 4、日期由 2 位数组成，例：1 号用“01”表示，10 号用“10”表示，依此类推。
- 5、工单流水号由四位数组成，从 0001、0002、0003……编号。
- 6、制造传票流水号由两位数组成，从 01、02、03……编号。

Cautions for Using Aluminum Electrolytic Capacitors

1. When reverse voltage is applied on DC aluminum electrolytic capacitor, the circuit will be short out and the capacitor will be damaged due to abnormal current flows through the capacitor. Please use non-polar types of capacitors when the positive voltage is applied on the cathode terminal.
2. When capacitor is used at higher voltage than the rated voltage, leakage current increased, characteristics drastically deteriorated and damaged in a short period may occur as a result. Please take extra caution that the peak voltage should not exceed the rated voltage.
3. Sudden charge and discharge
When aluminum electrolytic capacitors for general purpose-use are employed in rapid charge and discharge application, its life expectancy may be shortened resulted from capacitance decrease, heat rise, etc.
4. Storage of the capacitor
 - ① We recommend the following conditions for storage:
Ambient temperature: 5~35°C, Ambient humidity: <75%RH;
 - a) Storage life: ≤ 12 months;
 - b) **If storage life >12 months, the products need to be charged again before using;**
 - c) If Storage time >three years, the products need to be discarded;
 - d) Expiry Date: calculating from the date marked on the sleeve;
 - e) Please keep capacitors in the original package;
 - f) Avoid storing the capacitors under such circumstances:
 - ※ With water and oil or damp & dewing location.
 - ※ With gas and oil.
 - ※ With toxic gases such as hydrogen sulfide, sulfurous acid, nitrous acid, chlorine, bromine and methane.
 - ※ With direct sunlight, Ozone, ultraviolet rays or radiation.
5. If excessive ripple current is applied on the capacitor, excessive heat will be generated inside, the capacitance will be reduced and capacitor's life shall be shortened. Rated voltage has been marked on the capacitor; therefore, the peak value of the ripple voltage should be less than the rated voltage.
6. Ambient temperature
Life of aluminum electrolytic capacitor is affected by the ambient temperature. It is generally known that the life doubles for each 10°C decrease in temperature.
7. Tensile strength of lead wire
When a strong force is applied to the lead wires or terminals, stress is put on the internal connections, which may result in short circuit, open circuit or increased leakage current. So it is not advisable to bend or handle a capacitor after it has been soldered to the PC board.
8. Heat resistance at the soldering process
During soldering process, secondary shrinkage or sleeve crack may occur when soldering temperature is too high or soldering time is too long.

9. Hole pitch and position of PC board

When designing a PC board, its hole pitch should be designed to coincide with the lead pitch(lead spacing) of the capacitor specified in the catalog or specifications. When a capacitor is forcibly inserted into an unmatched hole pitch, a force will be put on the leads and which could result in a short circuit or increased leakage current.

10. Cleaning after soldering

① The aluminum electrolyte capacitors should be free halogenated solvents during board cleaning after soldering. Use solvent proof capacitors when halogenated solvents are used.

② After cleaned with the solvent which should proof the quality of capacitors, the capacitors should not be kept in solvent environments of non-ventilated places. Let the capacitors after cleaning dry with hot blast fully above 10mins and the temperature of hot blast should not be over than specified upper limit of capacitors.

11. Adhesives, fixative and coating materials(coating agent)

① Do not use halogenated adhesives and coating materials to fix aluminum electrolytic capacitors.

② Do not cover up all the sealing area of capacitors with adhesives, fixative or coating materials(coating agent), make coverage only partial

12. Certificates

① ISO 9001:2008 Certificate

② ISO 14001:2004 Certificate

③ ISO/TS 16949:2009 Certificate

④ OHSAS 18001:2007 Certificate

※ 符合 RoHS2.0 RoHS compliance

Accord with the latest standard of RoHS2.0, if customers have any special requirements, according to the relevant agreements which signed by both parts.