



### FEATURES

- UL60950 recognised
- RoHS compliant
- Typical efficiency from 83%
- Power density 2.68W/cm<sup>3</sup>
- Wide temperature performance at full 3 Watt load, -40°C to 85°C<sup>3</sup>
- UL 94V-0 package material
- No heatsink required
- Industry standard pinout
- 5V & 12V inputs
- 5V, 9V, 12V & 15V outputs
- Fully encapsulated with toroidal magnetics
- No external components required
- No electrolytic or tantalum capacitors

### PRODUCT OVERVIEW

The MEE3 series is a new range of high performance 3W DC-DC converters, offering 3W of available output power in a previously rated 2W package capable of operation over the full industrial temperature range of -40°C to 85°C<sup>3</sup>. Available in an industry standard SIP package, with a pin compatible power upgrade path from the 1W NME/NKE and 2W NML series<sup>1</sup>, they are ideally suited for providing local supplies on control system boards with the added benefit of 1kVDC galvanic isolation.

### SELECTION GUIDE

| Order Code  | Nominal Input Voltage | Output Voltage | Output Current | Input Current at Rated Load | Load Regulation (Typ) | Load Regulation (Max) | Ripple & Noise (Typ) <sup>1</sup> | Ripple & Noise (Max) <sup>1</sup> | Efficiency (Min.) | Efficiency (Typ.) | Isolation Capacitance | MTTF |
|-------------|-----------------------|----------------|----------------|-----------------------------|-----------------------|-----------------------|-----------------------------------|-----------------------------------|-------------------|-------------------|-----------------------|------|
|             | V                     | V              | mA             | mA                          | %                     | %                     | mVp-p                             | mVp-p                             | %                 | %                 | pF                    | MHrs |
| MEE3S0505SC | 5                     | 5              | 600            | 703                         | 6.3                   | 8                     | 46                                | 70                                | 79                | 83                | 32                    | 3.9  |
| MEE3S0509SC | 5                     | 9              | 333            | 677                         | 5.2                   | 6.5                   | 28                                | 45                                | 84                | 87                | 50                    | 2.9  |
| MEE3S0512SC | 5                     | 12             | 250            | 691                         | 4.7                   | 6                     | 26                                | 45                                | 83                | 86                | 41                    | 4.2  |
| MEE3S0515SC | 5                     | 15             | 200            | 679                         | 4.7                   | 6.5                   | 24                                | 45                                | 85                | 88                | 51                    | 2.5  |
| MEE3S1205SC | 12                    | 5              | 600            | 290                         | 4.3                   | 6                     | 41                                | 60                                | 82                | 85                | 42                    | 3.6  |
| MEE3S1209SC | 12                    | 9              | 333            | 280                         | 3.5                   | 5                     | 21                                | 40                                | 84                | 88                | 66                    | 3.7  |
| MEE3S1212SC | 12                    | 12             | 250            | 280                         | 3                     | 4.5                   | 19                                | 40                                | 84                | 88                | 77                    | 3.4  |
| MEE3S1215SC | 12                    | 15             | 200            | 277                         | 2.7                   | 4                     | 21                                | 40                                | 85                | 89                | 91                    | 3.4  |

### INPUT CHARACTERISTICS

| Parameter                | Conditions                            | Min. | Typ. | Max. | Units  |
|--------------------------|---------------------------------------|------|------|------|--------|
| Voltage range            | Continuous operation, 5V input types  | 4.5  | 5    | 5.5  | V      |
|                          | Continuous operation, 12V input types | 10.8 | 12   | 13.2 |        |
| Reflected ripple current | 5V input types                        |      | 5    | 15   | mA p-p |
|                          | 12V input types                       |      | 5    | 15   |        |

### GENERAL CHARACTERISTICS

| Parameter           | Conditions | Min. | Typ. | Max. | Units |
|---------------------|------------|------|------|------|-------|
| Switching frequency |            |      | 60   |      | kHz   |

### OUTPUT CHARACTERISTICS

| Parameter                  | Conditions                                  | Min. | Typ. | Max. | Units |
|----------------------------|---|------|------|------|-------|
| Rated Power                | T <sub>A</sub> = -40°C to 85°C              |      |      | 3    | W     |
| Voltage Set Point Accuracy | See tolerance envelope                      |      |      |      |       |
| Line regulation            | High V <sub>IN</sub> to low V <sub>IN</sub> |      | 1.01 | 1.1  | %/%   |

### ISOLATION CHARACTERISTICS

| Parameter              | Conditions                | Min. | Typ. | Max. | Units |
|------------------------|---------------------------|------|------|------|-------|
| Isolation test voltage | Flash tested for 1 second | 1000 |      |      | VDC   |
| Resistance             | Viso = 1000VDC            | 10   |      |      | GΩ    |

### TEMPERATURE CHARACTERISTICS

| Parameter                           | Conditions   | Min. | Typ. | Max. | Units |
|-------------------------------------|--|------|------|------|-------|
| Specification                       | All output types, See safety approval section for UL temperature specification | -40  |      | 85   | °C    |
| Storage                             |  | -50  |      | 125  |       |
| Case Temperature rise above ambient | MEE3Sxx05SC, MEE3S0512C  |      |      | 40   |       |
|                                     | MEE3S0515C, MEE3S1209C, MEE3S1212C   |      |      | 35   |       |
|                                     | MEE3S1215C, MEE3S0509C   |      |      | 30   |       |
| Cooling                             | Free air convection  |      |      |      |       |



For full details go to <https://www.murata.com/en-global/products/power/rohs>



1. See Ripple & Noise characterisation method.
  2. Calculated using MIL-HDBK-217F FN2 with nominal input voltage at full load.
  3. See safety approval section on page 2.
- All specifications typical at T<sub>A</sub> = 25°C, nominal input voltage and rated output current unless otherwise specified.

| ABSOLUTE MAXIMUM RATINGS                      |  |
|---|--|
| Lead temperature 1mm from case for 10 seconds | 260°C  |
| Wave Solder                                   | Wave Solder profile not to exceed the profile recommended in IEC 61760-1 Section 6.1.3. Please refer to <a href="#">application notes</a> for further information. |
| Input voltage $V_{IN}$ , MEE3S05 types        | 7V   |
| Input voltage $V_{IN}$ , MEE3S12 types        | 15V  |

**TECHNICAL NOTES**

**ISOLATION VOLTAGE**

'Hi Pot Test', 'Flash Tested', 'Withstand Voltage', 'Proof Voltage', 'Dielectric Withstand Voltage' & 'Isolation Test Voltage' are all terms that relate to the same thing, a test voltage, applied for a specified time, across a component designed to provide electrical isolation, to verify the integrity of that isolation.

Murata Power Solutions MEE3 series of DC-DC converters are all 100% production tested at their stated isolation voltage. This is 1kVDC for 1 second.

A question commonly asked is, "What is the continuous voltage that can be applied across the part in normal operation?"

The MEE3 series has been recognised by Underwriters Laboratory for functional isolation. Both input and output should normally be maintained within SELV limits i.e. less than 42.4V peak, or 60VDC. The isolation test voltage represents a measure of immunity to transient voltages and the part should never be used as an element of a safety isolation system. The part could be expected to function correctly with several hundred volts offset applied continuously across the isolation barrier; but then the circuitry on both sides of the barrier must be regarded as operating at an unsafe voltage and further isolation/insulation systems must form a barrier between these circuits and any user-accessible circuitry according to safety standard requirements.

**REPEATED HIGH-VOLTAGE ISOLATION TESTING**

It is well known that repeated high-voltage isolation testing of a barrier component can actually degrade isolation capability, to a lesser or greater degree depending on materials, construction and environment. The MEE3 series has toroidal isolation transformers, with no additional insulation between primary and secondary windings of enamelled wire. While parts can be expected to withstand several times the stated test voltage, the isolation capability does depend on the wire insulation. Any material, including this enamel (typically polyurethane) is susceptible to eventual chemical degradation when subject to very high applied voltages thus implying that the number of tests should be strictly limited. We therefore strongly advise against repeated high voltage isolation testing, but if it is absolutely required, that the voltage be reduced by 20% from specified test voltage.

This consideration equally applies to agency recognised parts rated for better than functional isolation where the wire enamel insulation is always supplemented by a further insulation system of physical spacing or barriers.

**SAFETY APPROVAL**

**UL60950**

The MEE3 series has been recognised by Underwriters Laboratory (UL) to UL60950 for functional isolation in a maximum still air ambient temperature of 63°C and/or case temperature limit of 91°C. Case temperature measured on the face opposite the pins.

**FUSING**

The MEE3 series of converters are not internally fused so to meet the requirement of UL60950, an input line fuse should always be used. An anti-surge 2.5A should be used for MEE3S05XXSC models, and an anti-surge 1A should be used for MEE3S12xxSC models.

All fuses should be UL recognised and rated to at least the maximum allowable DC input voltage.

File number E151252 applies.

**RoHS COMPLIANT INFORMATION**



This series is compatible with RoHS soldering systems with a peak wave solder temperature of 260°C for 10 seconds. Please refer to [application notes](#) for further information. The pin termination finish is Tin Plate, Hot Dipped over Matte Tin with Nickel Preplate. They are backward compatible with Sn/Pb soldering systems.

For further information, please visit [www.murata.com/en-global/products/power/rohs](http://www.murata.com/en-global/products/power/rohs)

**PART NUMBER STRUCTURE**

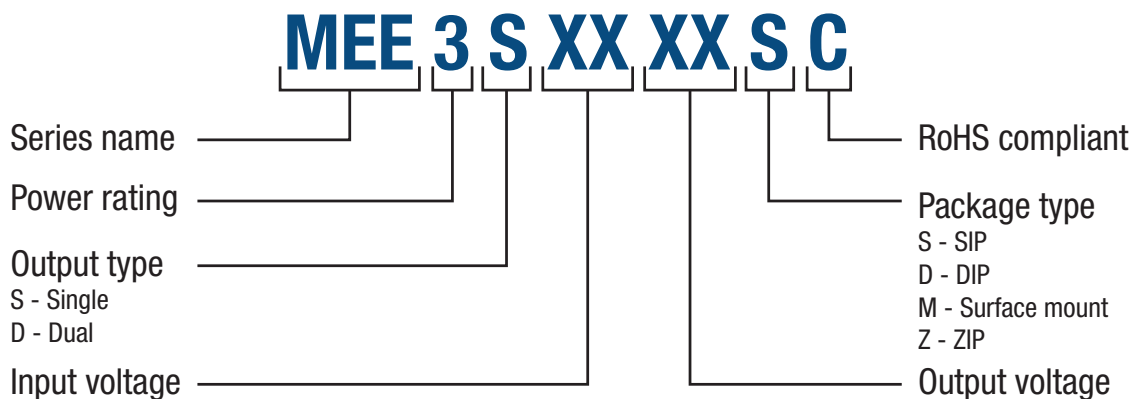

### ENVIRONMENTAL VALIDATION TESTING

The following tests have been conducted on this product series, please contact Murata if further information about the tests is required.

| Test                     | Standard  | Condition   |
|--------------------------|---|---|
| Temperature cycling      | MIL-STD-883 1010                                      | 10 cycles between two chambers set to achieve -55°C and +125°C. The dwell time shall not be less than 10 min and the load shall reach the specified temperature in 15 mins.   |
| Solderability            | EIA/IPC/JEDEC J-STD-002                               | SnPb (Test A) For leaded solderability the parts are conditioned in a steam ager for 8 hours ±15 min. at a temperature of 93°C ±3°C. Dipped in solder at 245°C ±5°C for 5 (+0/-0.5) seconds.<br>Pb-free (Test A1) For lead free solderability the parts are conditioned in a steam ager for 8 hours ±15 min. at a temperature of 93°C ±3°C. Dipped in solder at 255°C ±5°C for 5 (+0/-0.5) seconds. |
| Solder heat              | JEDEC JESD22-B106                                     | The test sample is subjected to a molten solder bath at 260 ±5°C for 10 (+2/-0) seconds (96SC tin/silver/copper).   |
| Solvent cleaning         | Resistance to cleaning agents                         | Parts are subjected to 3 minutes in the vapour tank, followed by 3 minutes in the ultrasonic tank and a further 3 minutes in the vapour tank, at an operating temperature of 70.6°C.  |
| Lead integrity: pull     | MIL-STD 883 Method 2004 Test Condition A              | A pull of 0.227kg applied for 30 seconds. The force is then increased until the pins snap.  |
| Lead integrity: fatigue  | MIL-STD 883 Method 2004 Test condition B <sub>2</sub> | The leads are bent to an angle of 15°. Each lead is subjected to 3 cycles.  |
| Lead integrity: adhesion | MIL-STD 883 Method 2025                               | Leads are bent through 90° until a fracture occurs.   |

**CHARACTERISATION TEST METHODS**

**Ripple & Noise Characterisation Method**

Ripple and noise measurements are performed with the following test configuration.

|       |  |
|-------|--|
| C1    | 1µF X7R multilayer ceramic capacitor, voltage rating to be a minimum of 3 times the output voltage of the DC-DC converter                                |
| C2    | 10µF tantalum capacitor, voltage rating to be a minimum of 1.5 times the output voltage of the DC-DC converter with an ESR of less than 100mΩ at 100 kHz |
| C3    | 100nF multilayer ceramic capacitor, general purpose  |
| R1    | 450Ω resistor, carbon film, ±1% tolerance  |
| R2    | 50Ω BNC termination  |
| T1    | 3T of the coax cable through a ferrite toroid  |
| RLOAD | Resistive load to the maximum power rating of the DC-DC converter. Connections should be made via twisted wires  |

Measured values are multiplied by 10 to obtain the specified values.

**Differential Mode Noise Test Schematic**

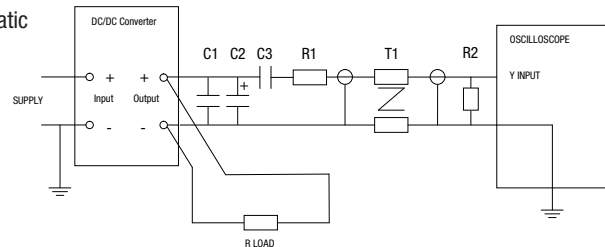

**APPLICATION NOTES**

**Output Ripple Reduction**

By using the values of inductance and capacitance stated, the output ripple at the rated load is lowered to 5mV p-p max.

**Component selection**

**Capacitor:** It is required that the ESR (Equivalent Series Resistance) should be as low as possible, ceramic types are recommended. The voltage rating should be at least twice (except for 15V output), the rated output voltage of the DC-DC converter.

**Inductor:** The rated current of the inductor should not be less than that of the output of the DC-DC converter. At the rated current, the DC resistance of the inductor should be such that the voltage drop across the inductor is <2% of the rated voltage of the DC-DC converter. The SRF (Self Resonant Frequency) should be >20MHz.

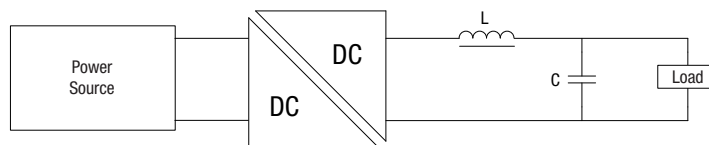

|             | Inductor |        |              | Capacitor |
|-------------|----------|--------|--------------|-----------|
|             | L, µH    | SMD    | Through Hole | C, µF     |
| MEE3S0505SC | 10       | 84103C | 11R103C      | 4.7       |
| MEE3S0509SC | 22       | 84223C | 11R223C      | 2.2       |
| MEE3S0512SC | 47       | 84473C | 11R473C      | 1         |
| MEE3S0515SC | 47       | 84473C | 11R473C      | 1         |
| MEE3S1205SC | 10       | 84103C | 11R103C      | 4.7       |
| MEE3S1209SC | 22       | 84223C | 11R223C      | 2.2       |
| MEE3S1212SC | 47       | 84473C | 11R473C      | 1         |
| MEE3S1215SC | 47       | 84473C | 11R473C      | 1         |

**APPLICATION NOTES (Continued)**

**Minimum Load**

The minimum load to meet datasheet specification is 10% of the full rated load across the specified input voltage range. Lower than 10% minimum loading will result in an increase in output voltage, which may rise to typically 1.25 times the specified output voltage if the output load falls to less than 5%.

**Capacitive Loading & Start Up**

Typical start up times for this series, with a typical input voltage rise time of 2.2µs with resistive only load, and with added output capacitance of 47µF, are shown in the table below

| Part Number | Start-Up Time<br>µS |
|-------------|---------------------|
| MEE3S0505SC | 490                 |
| MEE3S0509SC | 1130                |
| MEE3S0512SC | 2070                |
| MEE3S0515SC | 3515                |
| MEE3S1205SC | 415                 |
| MEE3S1209SC | 715                 |
| MEE3S1212SC | 1100                |
| MEE3S1215SC | 1430                |

Typical Start-Up Wave Form

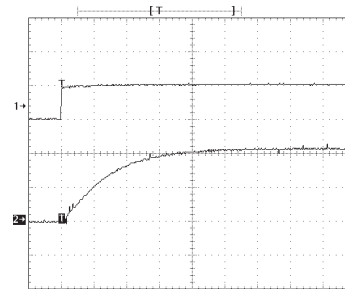

## TOLERANCE ENVELOPES

The voltage tolerance envelope shows typical load regulation characteristics for this product series. The tolerance envelope is the maximum output voltage variation due to changes in output loading.

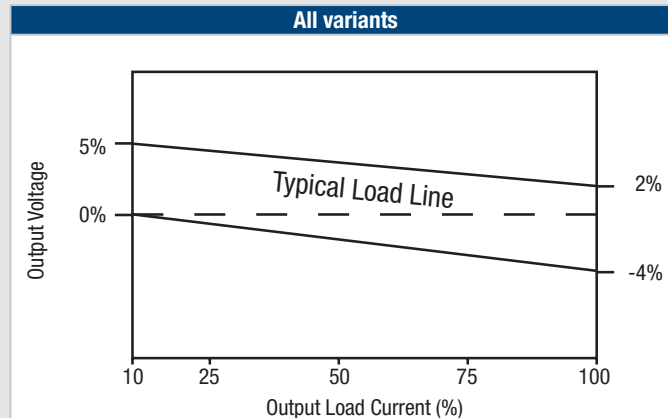

## TEMPERATURE DERATING GRAPH

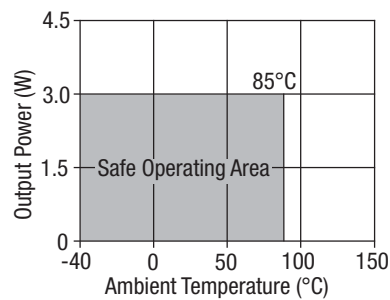

## EFFICIENCY VS LOAD

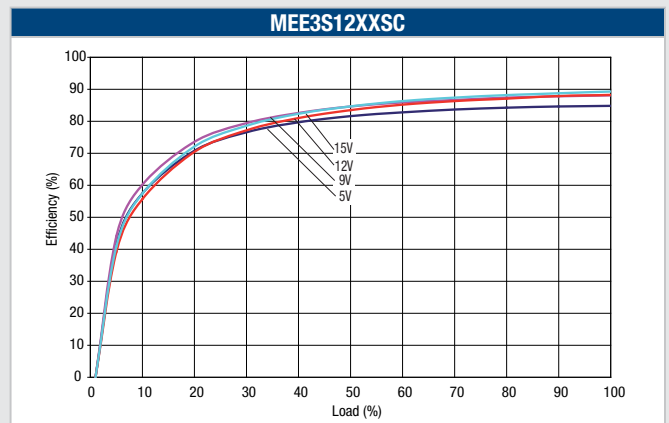
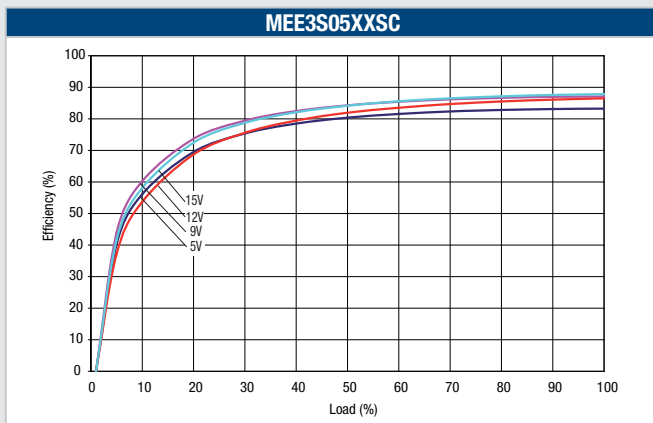

**PACKAGE SPECIFICATIONS**

**MECHANICAL DIMENSIONS**

SIP Package

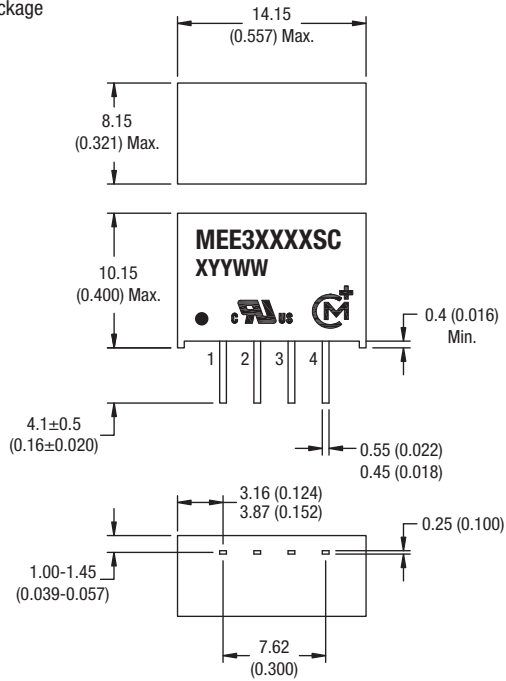

All dimensions in mm  $\pm 0.1$ mm (inches  $\pm 0.004$ ). All pins on a 2.54 (0.1) pitch and within  $\pm 0.25$  (0.01) of true position.

Weight: 2.3 g

**PIN CONNECTIONS - 4 PIN SIP**

| Pin | Function |
|-----|----------|
| 1   | -VIN     |
| 2   | +VIN     |
| 3   | -VOUT    |
| 4   | +VOUT    |

**TUBE OUTLINE DIMENSIONS**

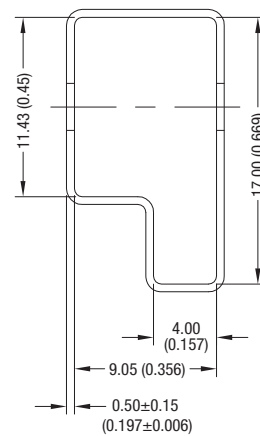

Unless otherwise stated all dimensions in mm (inches)  $\pm 0.5$ mm. Tube length: 520mm  $\pm 2$ mm (20.47).

Tube Quantity: 35

**RECOMMENDED FOOTPRINT DETAILS**

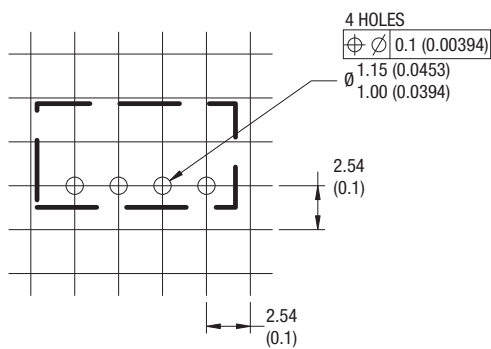

Unless otherwise stated all dimensions in mm (inches)  $\pm 0.5$ mm.



**DISCLAIMER**

Unless otherwise stated in the datasheet, all products are designed for standard commercial and industrial applications and NOT for safety-critical and/or life-critical applications.

Particularly for safety-critical and/or life-critical applications, i.e. applications that may directly endanger or cause the loss of life, inflict bodily harm and/or loss or severe damage to equipment/property, and severely harm the environment, a prior explicit written approval from Murata is strictly required. Any use of Murata standard products for any safety-critical, life-critical or any related applications without any prior explicit written approval from Murata shall be deemed unauthorised use.

These applications include but are not limited to:

- Aircraft equipment
- Aerospace equipment
- Undersea equipment
- Power plant control equipment
- Medical equipment
- Transportation equipment (automobiles, trains, ships, etc.)
- Traffic signal equipment
- Disaster prevention / crime prevention equipment
- Data Processing equipment

Murata makes no express or implied warranty, representation, or guarantee of suitability, fitness for any particular use/purpose and/or compatibility with any application or device of the buyer, nor does Murata assume any liability whatsoever arising out of unauthorised use of any Murata product for the application of the buyer. The suitability, fitness for any particular use/purpose and/or compatibility of Murata product with any application or device of the buyer remain to be the responsibility and liability of the buyer.

Buyer represents and agrees that it has all the necessary expertise to create and implement safeguards that anticipate dangerous consequences of failures, monitor failures and their consequences, lessen the likelihood of failures that might cause harm, and take appropriate remedial actions. Buyer will fully indemnify and hold Murata, its affiliated companies, and its representatives harmless against any damages arising out of unauthorised use of any Murata products in any safety-critical and/or life-critical applications.

Remark: Murata in this section refers to Murata Manufacturing Company and its affiliated companies worldwide including, but not limited to, Murata Power Solutions.



This product is subject to the following [operating requirements](https://www.murata.com/en-eu/products/power/requirements) and the [Life and Safety Critical Application Sales Policy](https://www.murata.com/en-eu/products/power/requirements):

Refer to: <https://www.murata.com/en-eu/products/power/requirements>

Murata Power Solutions (Milton Keynes) Ltd. makes no representation that the use of its products in the circuits described herein, or the use of other technical information contained herein, will not infringe upon existing or future patent rights. The descriptions contained herein do not imply the granting of licenses to make, use, or sell equipment constructed in accordance therewith. Specifications are subject to change without notice.

© 2024 Murata Power Solutions (Milton Keynes) Ltd.