

Infrared Array Sensor Grid-EYE

Surface Mount Type

AMG88x543 (Wide angle type)

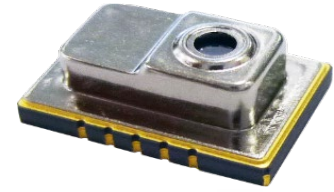

Feature

- Temperature detection of two-dimensional area: 8 × 8 (64 pixels)
- Digital output (capability of temperature value output)
- Compact SMD package (adaptively to reflow mounting)
- RoHS compliant

Recommended applications

- Energy saving at office (air-conditioning/lighting control)
- Automatic doors/elevators

Ordering information

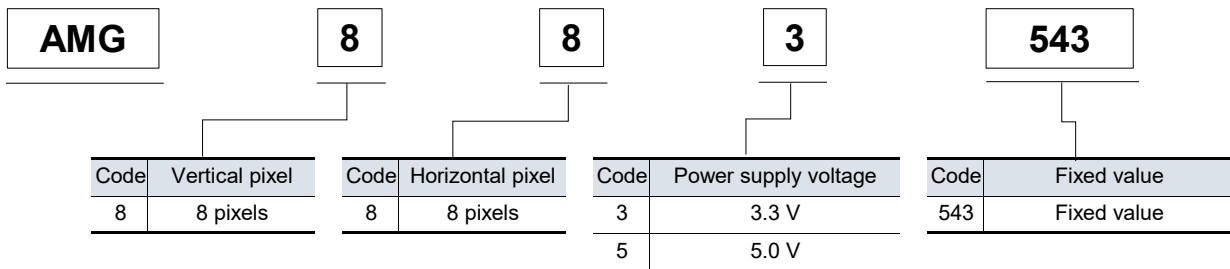

Types

Product name	Number of pixel	Operating voltage	Part number	Tape and reel package (pcs)
Infrared array sensor Grid-EYE	64 (Vertical 8 × Horizontal 8 Matrix)	3.3 V	AMG883543	1000
		5.0 V	AMG885543	

Rating

Item	Performance
Applied voltage	3.3 V ± 0.3 V or 5.0 V ± 0.5 V
Temperature range of measuring object	0 °C to 80 °C +32 °F to +176 °F
Operating temperature range	0 °C to 80 °C +32 °F to +176 °F
Storage temperature range	-20 °C to 80 °C -4 °F to +176 °F

Absolute maximum ratings

Item	Absolute maximum ratings	Terminal
Applied voltage	-0.3 V to 6.5 V	VDD
Input/Output voltage	-0.3 V to VDD +0.3 V	SCL, SDA, AD_SELECT
Output sink current	-10 mA to 10 mA	INT, SDA
Static electricity (Human Body Model)	± 1 kV	All terminals
Static electricity (Machine Model)	± 200 V	All terminals

Characteristics

Item	Performance
Temperature accuracy ^{*1 *2}	Average value of total pixels is within Typ. $\pm 2.5^{\circ}\text{C}$ $\pm 4.5^{\circ}\text{F}$
NETD ^{*3}	1fps: Typ. 0.09°C 10fps: Typ. 0.27°C
Viewing angle	Typ. 90°
Optical axis gap	Within Typ. $\pm 10^{\circ}$
Current consumption	Typ. 4.5 mA (Normal mode) Typ. 0.2 mA (Sleep mode)
Setup time	Typ. 50 ms (Time to enable communication after setup) Typ. 15 s (Time to stabilize output after setup)

*1: Temperature output after starting in normal mode and waiting longer than setup time.

*2: The measurement conditions for guaranteed characteristic are as follows.

- Measurement equipment : inspection equipment in our manufacturing process
- Ambient humidity : standard humidity (Around 65%RH)
- Frame rate : 10fps
- Operation temperature : standard temperature (Around 20°C)

- Measurement object and temperature : black body, 25°C , 50°C , 75°C
- Moving average : setting off
- Measurement value of each pixel: Average value of multiple frame outputs
- Average value of all pixels: Average value of total pixels measurement values

*3: This value are central 4 pixels which are No.28, No.29, No.36, No.37.

Performance

Item	Performance
Number of pixel	64 (Vertical 8 × Horizontal 8 Matrix)
External interface	I ² C
Frame rate	Typ. 1 fps or Typ. 10 fps
Operating mode	Normal (Detection on) Sleep (Detection off)
Output mode	Temperature output
Calculate mode	No moving average or Twice moving average
Temperature output resolution	0.25°C 0.45°F
Number of sensor address	2 (I ² C slave address))
Thermistor output temperature range	-20°C to 80°C -4°F to $+176^{\circ}\text{F}$
Thermistor output resolution	0.0625°C 0.1125°F

Internal circuit

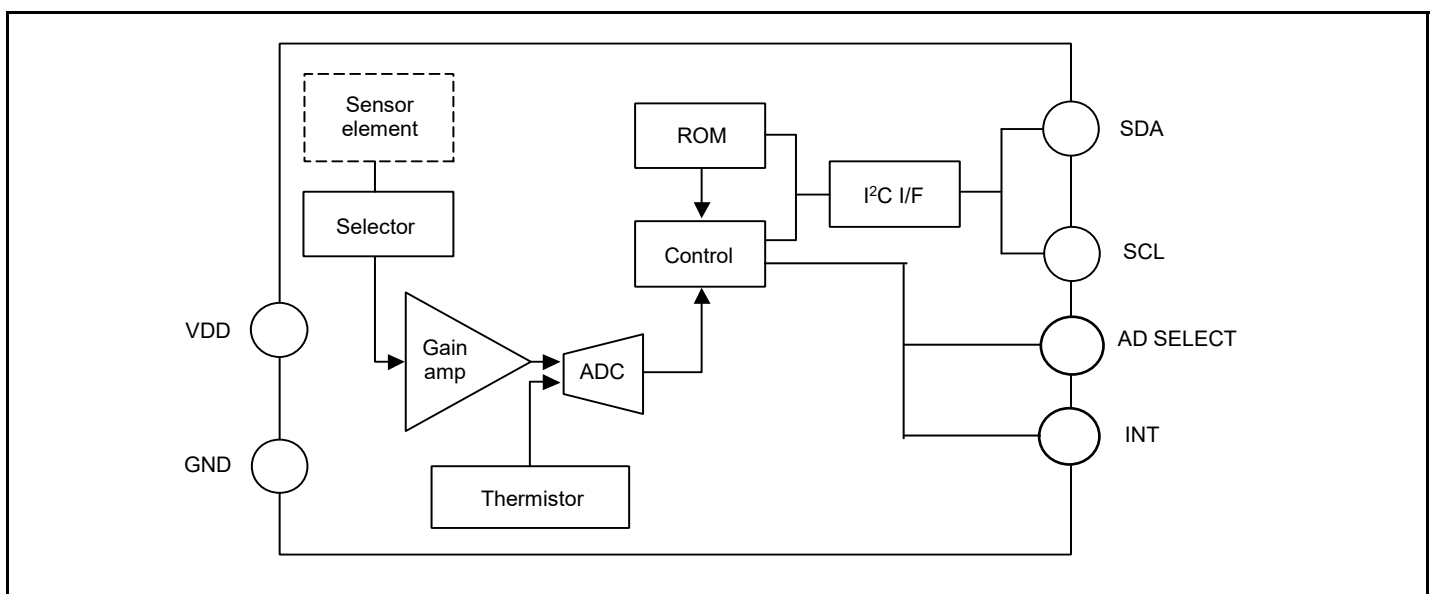

Pixel array and viewing angle

(1) Pixel array

Pixel array from 1 to 64 is shown below.

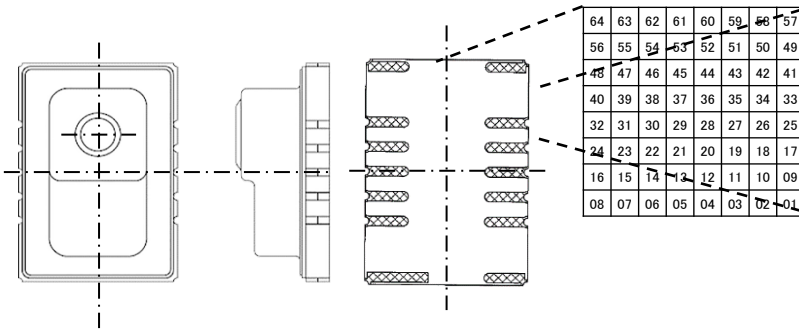

(2) Viewing angle (Typ.)

Sensor viewing angle is shown below.

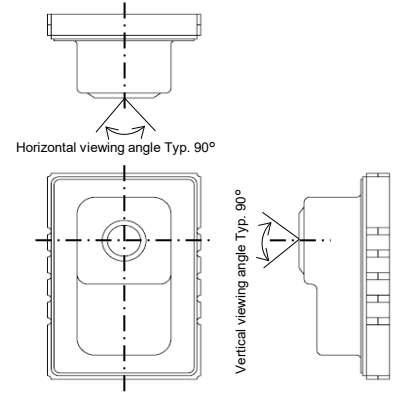

Optical properties

(1) Each pixel's viewing central angle (Typ.)

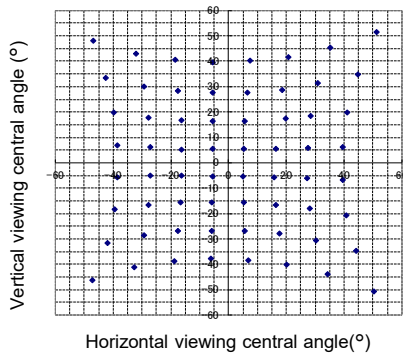

(2) Each pixel's viewing angle (Typ.)

Sensor viewing angle is shown below.

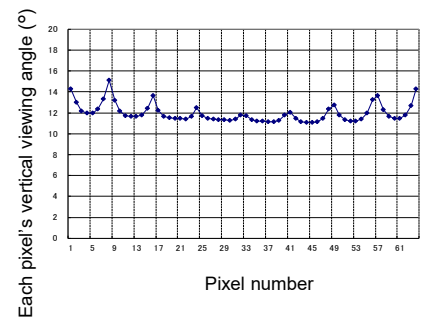
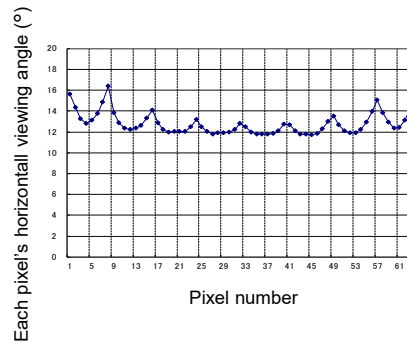

Dimensions

External dimensions (Typ.)

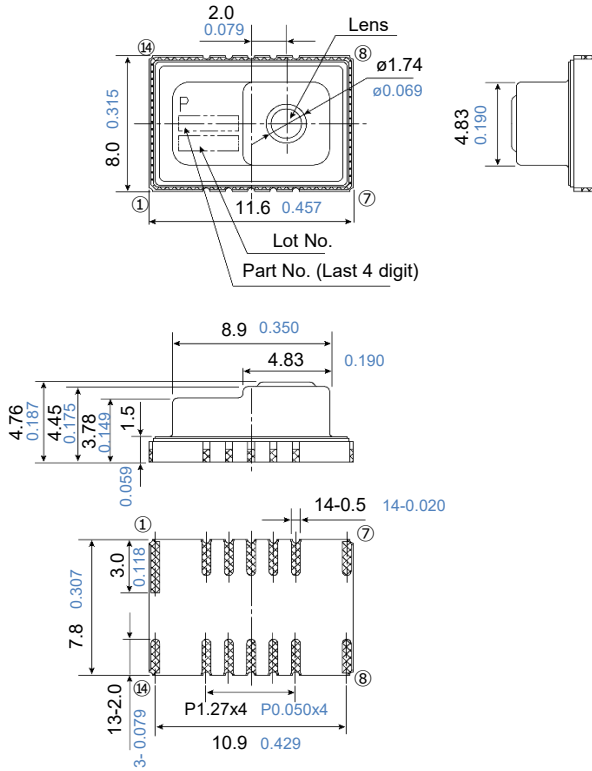

Recommended PC board pad (Typ.)

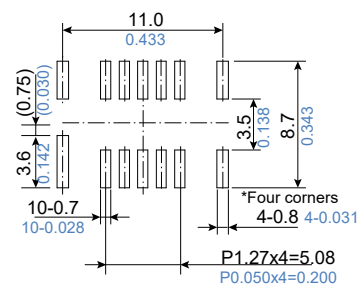

Number	Terminal name
①	NC
②	SDA
③	SCL
④	INT
⑤	AD_SELECT
⑥	GND
⑦	NC

Number	Terminal name
⑧	NC
⑨	VDD
⑩	AVDD-PC
⑪	NC
⑫	DVDD-PC
⑬	VPP
⑭	NC

Note) NC : Leave terminal unconnected.

Unit : mm inch

Safety and Legal Matters to Be Observed

Product specifications and applications

- Please be advised that this product and product specifications are subject to change without notice for improvement purposes. Therefore, please request and confirm the latest delivery specifications that explain the specifications in detail before the final design, or purchase or use of the product, regardless of the application. In addition, do not use this product in any way that deviates from the contents of the company's delivery specifications.
- Unless otherwise specified in this catalog or the product specifications, this product is intended for use in general electronic equipment (AV products, home appliances, commercial equipment, office equipment, information and communication equipment, etc.).
When this product is used for the following special cases, the specification document suited to each application shall be signed/sealed (with Panasonic Industry and the user) in advance..These include applications requiring special quality and reliability, wherein their failures or malfunctions may directly threaten human life or cause harm to the human body (e.g.: space/aircraft equipment, transportation/traffic equipment, combustion equipment, medical equipment, disaster prevention/crime prevention equipment, safety equipment, etc.).

Safety design and product evaluation

- Please ensure safety through protection circuits, redundant circuits, etc., in the customer's system design so that a defect in our company's product will not endanger human life or cause other serious damage.
- This catalog shows the quality and performance of individual parts. The durability of parts varies depending on the usage environment and conditions. Therefore, please ensure to evaluate and confirm the state of each part after it has been mounted in your product in the actual operating environment before use.
If you have any doubts about the safety of this product, then please notify us immediately, and be sure to conduct a technical review including the above protection circuits and redundant circuits at your company.

Laws / Regulations / Intellectual property

- The transportation of dangerous goods as designated by UN numbers, UN classifications, etc., does not apply to this product. In addition, when exporting products, product specifications, and technical information described in this catalog, please comply with the laws and regulations of the countries to which the products are exported, especially those concerning security export control.
- Each model of this product complies with the RoHS Directive (Restriction of the use of hazardous substances in electrical and electronic equipment) (2011/65/EU and (EU) 2015/863). The date of compliance with the RoHS Directive and REACH Regulation varies depending on the product model.
Further, if you are using product models in stock and are not sure whether or not they comply with the RoHS Directive or REACH Regulation, please contact us by selecting "Sales Inquiry" from the inquiry form.
- During the manufacturing process of this product and any of its components and materials to be used, Panasonic Industry does not intentionally use ozone-depleting substances stipulated in the Montreal Protocol and specific bromine-based flame retardants such as PBBs (Poly-Brominated Biphenyls) / PBDEs (Poly-Brominated Diphenyl Ethers). In addition, the materials used in this product are all listed as existing chemical substances based on the Act on the Regulation of Manufacture and Evaluation of Chemical Substances.
- With regard to the disposal of this product, please confirm the disposal method in each country and region where it is incorporated into your company's product and used.
- The technical information contained in this catalog is intended to show only typical operation and application circuit examples of this product. This catalog does not guarantee that such information does not infringe upon the intellectual property rights of Panasonic Industry or any third party, nor imply that the license of such rights has been granted.
- Design, materials, or process related to technical owned by Panasonic Industry are subject to change without notice.

Panasonic Industry will assume no liability whatsoever if the use of our company's products deviates from the contents of this catalog or does not comply with the precautions. Please be advised of these restrictions.

Matters to Be Observed When Using This Product

(Infrared array sensor / Grid-EYE)

Use environments

- The product introduced here is a thermopile infrared sensor that detects the amount of infrared. In the cases described below, power output from the sensor may change. You need to be careful about the sensor behavior in such cases. Confirm the performance and reliability of the sensor in its actual service condition. If necessary, adjust the power output for the actual service condition.
 - (1) Case where the sensor shows a partial temperature change because of a heater (MCU, heat source, etc.) present near the sensor, hot air or cool air hitting the sensor, or the sensor is in contact with the housing of equipment.
 - (2) Case where an obstacle is present between the sensor and a target object, e.g., an obstacle that transmits miniscule infrared rays (glass, acrylic, steam, etc.) is present between the sensor and the target object or foreign matter that transmits miniscule infrared rays (dust, waterdrop, etc.) deposits on the lens of the sensor.
- The sensor is used or mounted in an environment where the rated performance of the sensor specified in the specifications is guaranteed. To know the working temperature of the sensor, refer to its rated values. Keep the humidity in the service environment at 15% RH to 85% RH and avoid dew concentration as well as freezing. Use the sensor under an atmospheric pressure ranging from 86 kPa to 106 kPa.
- Vibrations or impacts applied to the sensor can damage the sensor, causing an operation failure, performance drop, etc. Be careful in such cases. A lens damaged by a load or impact applied can also cause an operation failure, performance drop, etc. Be careful in such cases.
- The sensor is not waterproof nor dustproof. In the service environment where the sensor is to be used, you need to take measures against moisture, dust, dew concentration, and freezing. A waterdrop on a soldered part causes electromigration along the soldered part, thus causing a short circuit. Make the soldered part waterproof.
- Avoid using or storing the sensor in a place where corrosive gas (organic solvent gas, sulfur dioxide gas, hydrogen sulfide gas, etc.) is present near the sensor. Using or storing the sensor in such a place may lead to an operation failure or performance drop.
- If an external voltage surge is applied to the sensor, the internal circuit may be destroyed. Use a surge absorber, etc., to prevent such a case.
- The sensor may malfunction when exposed to static electricity, lightning, or electric noise from a cellular phone, radio transmitter, broadcasting station, etc.
- The working ambient temperature (humidity) range is a temperature (humidity) range in which the sensor can be operated continuously. The humidity range, however, varies depending on temperature. Observe the humidity ranges shown in the following graphs. Avoid using the sensor continuously in a temperature (humidity) condition close to the limit of the temperature (humidity) range. This temperature range does not guarantee the durability of the sensor.

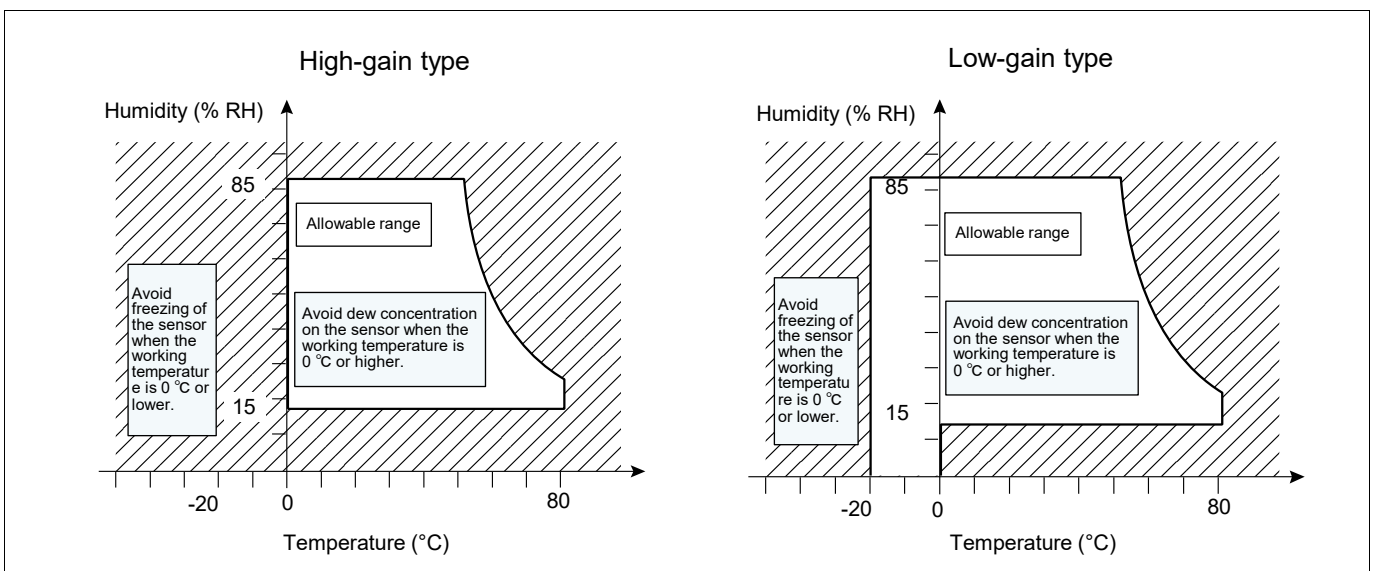

Response to anomalies and handling conditions

- When the sensor is heating abnormally or emitting a smell, stop using the sensor immediately by, for example, turning off its power supply.
- Do not use a sensor disassembled or remodeled, a sensor removed from the board, or a sensor dropped on the floor. High-frequency vibrations applied to the sensor may put it out of order. Do not use the sensor where impact will be applied from coming in contact with a metal object or another sensor.
- The sensor may fail under the influence of static electricity. When handling the sensor, wear anti-static clothes and make sure to ground the human body, measurement instruments/jigs used, and equipment for setting up the sensor.
- When foreign matter, waterdrops, etc., deposits on the lens, wipe it off gently with a soft cloth. Wiping the lens with a strong force can peel the lens off or damage the lens surface, causing problems. Be careful when cleaning the lens surface. Avoid cleaning the sensor with ultrasonic waves. This cleaning method may cause wire breakage and lead to a failure of the sensor.

Circuit design and circuit board design

- Confirm the pin arrangement by referring to specification drawings, etc., and connect leads correctly. Incorrect connection of the leads results in unexpected malfunctions, overheating, smoke generation, etc., which damage the circuit.
- Connect the sensor in accordance with the terminal connection diagram. Do not connect the sensor in reverse polarity to the power supply. It causes the sensor to fail or overheat.
Leave the free terminal unconnected. Connecting the free terminal creates a failure factor.
- Use a shielded cable to eliminate noise effects and make the cable as short as possible.
- Adopt a printed board with a land wide enough to affix the sensor thereon. When mounting the sensor on a printed board that is not the one recommended for it, sufficiently check the performance and quality of the sensor before using it.
- When power supplied to the sensor carries heavy noise, it may cause the sensor to malfunction. To ensure resistance to superposed power noise, set the recommended capacitor in the immediate vicinity of a section between input terminals (between a VDD node and a GND node), that is, in a location 20 mm distant in line length to the section.
Note, however, that you have to check the capacitor performance in the actual circuit configuration and reselect an optimum capacitor if necessary.
- The top of the sensor body (the surface where the product number is printed) serves as GND. Prevent any metal parts of other electronic components, etc., from coming in contact with this part.

Mounting conditions

- When soldering the sensor, reduce the effects of external heat on the sensor as much as possible. A sensor exposed to intensive heat thermally deforms, which may lead to its breakage or change in characteristics.
- When soldering the sensor manually, sufficiently clean the tip of the soldering iron and perform soldering within 3 seconds with a solder iron whose tip is heated to 350°C to 400°C (with a supplied power of 30 W to 60 W). Do not apply a load to the sensor terminals. It may change the output from the sensor.
- In the case of reflow soldering, we recommend solder-paste screen printing, which is a type of solder paste printing. When using highly active solder flux made mainly of halogen (chlorine, bromine, etc.), residual flux may affect the performance and reliability of the sensor. Check the effects of residual flux before using the solder flux.
- Self-alignment by solder may turn out to be insufficient. Align the sensor terminals with the wiring pattern carefully.

- A recommended reflow temperature profile is shown below. A profile temperature is defined as the temperature measurement taken at the printed board close to the sensor terminals. Assuming temperature measurement changes depending on board design details. Confirm, at the time of sensor mounting, that the printed board temperature measured at a point close to the sensor terminals matches the specified profile temperature and then mount the sensor.

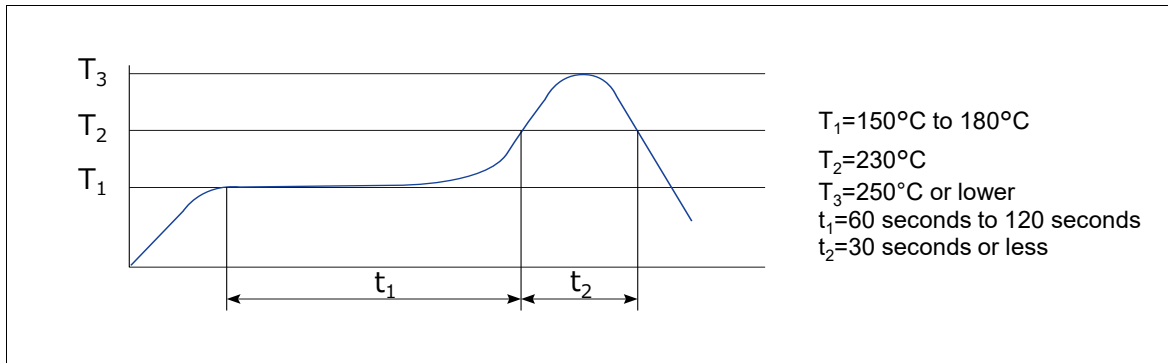

- When reflow-soldering the back of the board, after reflow-soldering the sensor, carry out a fixing process using, for example, an adhesive.
- When coating the board to prevent the degradation in insulation performance after the soldering process, be careful not to let any chemical stick to the lens of the sensor.
- When fixing the sensor by cutting/folding the board or using screws, etc., after mounting the sensor on the board, make sure that no stress is applied to the sensor or its soldered parts.
- Complete rework on soldered parts in a single process. When reworking a solder bridge, use a soldering iron with a flat tip and do not add solder flux to the bridge.
- The sensor has terminals exposed outside. If a metal piece, etc., comes in contact with the terminals, the sensor will output abnormal signals. Do not let a metal piece, a finger, etc., touch the sensor. Do not touch the sensor with bare hands. Wear gloves when handling the sensor.

Storage and transportation conditions

- Vibrations or impacts applied to the sensor during transportation may break the sensor. Handle the outer casing and reel carefully.
- Storing the sensor in an extremely unfavorable conditions may result in the lower solderability, damaged appearance, and degraded characteristics of the sensor. Store the sensor in a place where the temperature ranges from 0°C to 45°C , the humidity is 70% RH or lower, no sea breeze or corrosive gas (Cl_2 , H_2S , NH_3 , SO_2 , NO_x , etc.), little dust present, and direct sunlight is blocked.
- Because the sensor is susceptible to moisture, it is sealed in a moisture proof package. After the moisture proof package is unsealed, the sensor must be kept under storage conditions of 30°C and 60% RH and be used within one week. When keeping a sensor in storage for a long period (less than three months) after taking it out of the moisture proof package, put the sensor in a moisture proof bag filled with silica gel to protect the sensor from moisture.
- When using a sensor kept in storage for a long period, dry the sensor before subjecting it to the reflow-soldering process. When a sensor that has absorbed moisture is exposed to heat stress during the soldering process, moisture inside the sensor evaporates into expanding steam, creating internal stress that may swell or crack the sensor surface. Be mindful of the sensor's moisture absorption state and soldering conditions.
- Static electricity may destroy the sensor. Store and transport the sensor in an environment where no/little static electricity is generated (humidity 45% to 60%), and protect the sensor from static electricity by covering it with a conductive packaging material. When storing or transporting a sensor taken out of the package, put the sensor in an antistatic container.