

data sheet

pco. pixelfly 1.4 USB

digital 14 bit CCD camera

resolution

1.4 MPixel

pixel size

6.45 μm x 6.45 μm

interface

USB 2.0



low noise
6 electrons

quantum efficiency
up to 62 %

housing: ultra
compact design

resolution 1.4 MPixel

available in mono
and color

pco.

An Excelitas Technologies Brand

technical data

image sensor

sensor technology	CCD
color type	monochrome or color
resolution (horizontal x vertical)	1392 pixel x 1040 pixel (normal) 800 pixel x 600 pixel (center ROI)
pixel size (horizontal x vertical)	6.45 μm x 6.45 μm
sensor size (horizontal x vertical)	9.0 mm x 6.7 mm
sensor diagonal	11.2 mm
shutter type	global shutter (snapshot)
modulation transfer function (theoretical max.)	77.5 lp/mm
fullwell capacity	16.000 e ⁻ 24.000 e ⁻ (binning)
readout noise (typ.)	5 .. 7 e ⁻ rms @ 12 MHz (typ.) 6 .. 8 e ⁻ rms @ 24 MHz (typ.)
dynamic range (intra-scene)	2 667 : 1 (68.0 dB) 4 000 : 1 (72.0 dB, binning)
peak quantum efficiency	62 % @ peak
spectral range	290 nm - 1100 nm
dark current	1 e ⁻ /pixel/s @ +23 °C sensor temperature

frame rate table

resolution	normal (1392 pixel x 1040 pixel)		center (800 pixel x 600 pixel)	
pixelclock (MHz)	12	24	12	24
frame rate	7.3 fps	13.5 fps	11.7 fps	21.6 fps
frame rate x2 binning	14.7 fps	27.0 fps	21.8 fps	40.4 fps
frame rate x4 binning	27.0 fps	47.0 fps	35.0 fps	62.0 fps



camera

max. frame rate @ full resolution	7.3 / 13.5 fps (12 / 24 MHz, normal) 11.7 / 21.6 fps (12 / 24 MHz, center)
exposure time range	1 μ s - 60 s
dynamic range A/D	14 bit
conversion factor¹	1.0 e ⁻ /count 1.5 e ⁻ /count
pixel scan rate	12 MHz / 24 MHz
pixel data rate	19.5 MPixel/s
binning	x1, x2, x4
non-linearity	< 1 %
smear	< 0.002 %
dark signal non-uniformity (DSNU)²	< 2 e ⁻ rms
photo response non-uniformity (PRNU)³	< 1 %
trigger input signals	software / TTL level
trigger output signals	3.3 V LVTTTL level
input / output signal interface	SMA connectors
time stamp	in image (1 μ s resolution)
data interface	USB 2.0

¹ According to EMVA1288 the conversion factor equals the inverse of the system gain and can be operational mode dependent.

² dark signal non-uniformity measured in a 90 % center zone of the image sensor

³ photo response non-uniformity

quantum efficiency

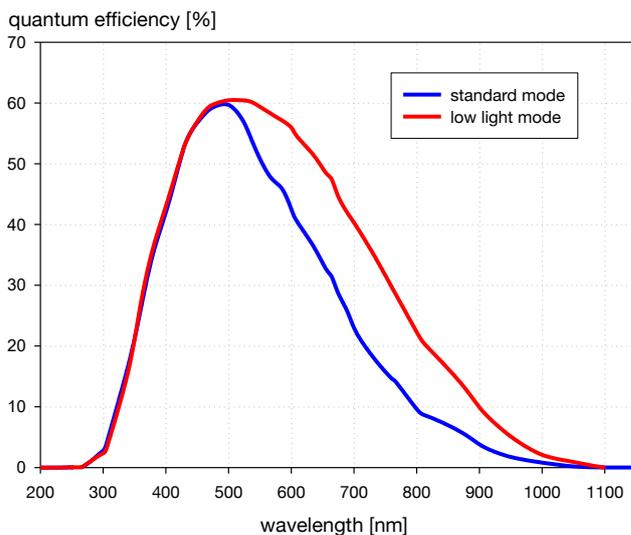

The diagram is representative for the monochrome version.

Standard light mode: Ideal for exposure times up to 60 s / Maximum anti blooming function / Minimum fixed pattern in bright CCD areas / Linear operation up to full well capacity.

Low light mode: Ideal for exposure times from 1ms to approximately 10 s / Antiblooming function is reduced to about 4-time overexposure.

general

power supply	9 .. 28 VDC (12 VDC typ.)
power consumption	< 4 W
weight	0.25 kg
dimensions (height x width x length)	70 mm x 70 mm x 115 mm
operating temperature range	+10 °C to +45 °C
operating humidity range (non-condensing)	10 % to 80 % (non-condensing)
storage temperature range	-20 °C to +70 °C
CE / FCC certified	yes
lens mounting	C-Mount

Configure your optical setup with our **MachVis Lens Selector** online tool.

dimensions

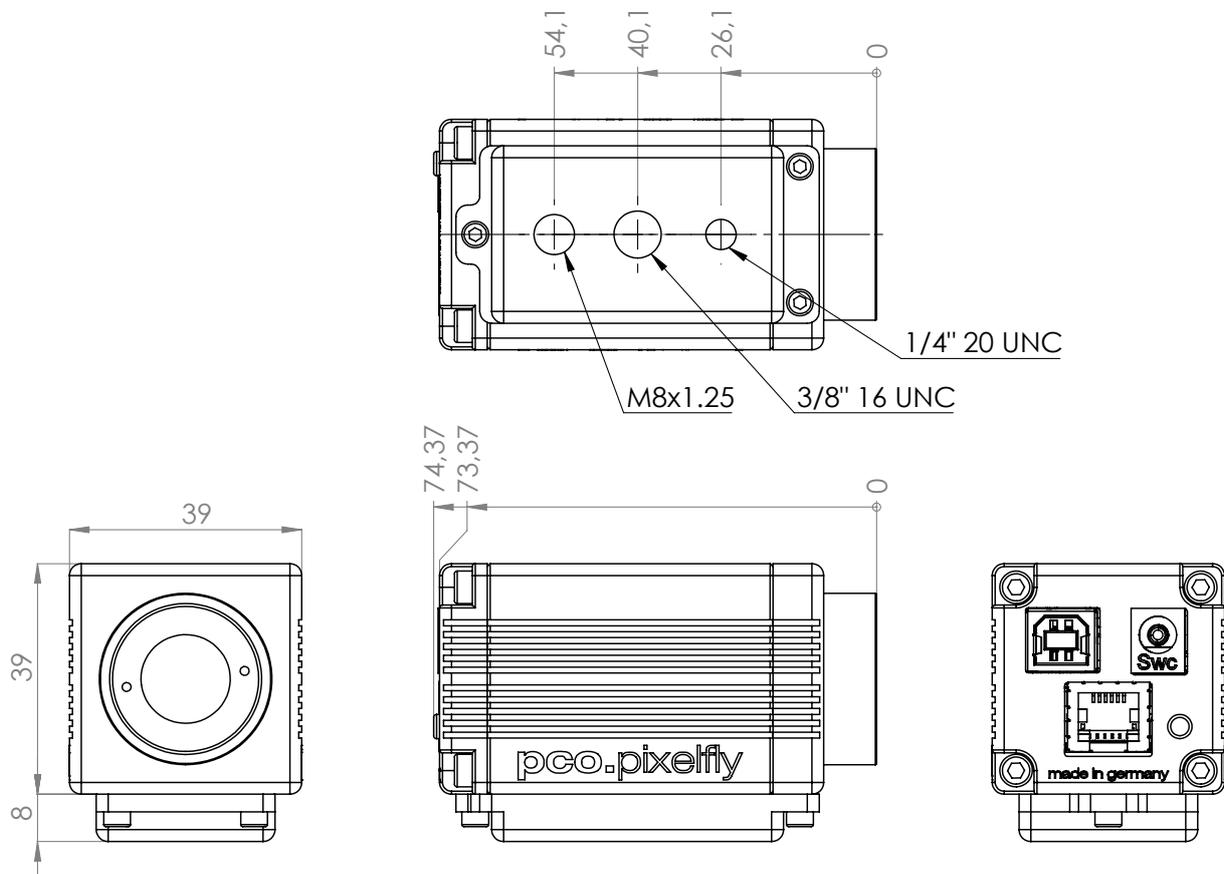

Outlines of pco.pixelfly 1.4 USB (all dimensions given in mm).

software

Our main camera control software pco.camware is the first choice to get started with your camera. It enables full control of all camera settings and makes image acquisition and storage very easy. Using different layouts, styles and features you can customize it exactly to your needs.



You are using a different software:

PCO cameras are also integrated in a variety of software applications. Check our homepage to find a list of all applications that support PCO cameras.

Your use case is in the field of microscopy:

PCO cameras are also integrated in μ Manager.



areas of application

scientific imaging | low light level imaging | combustion imaging | high resolution microscopy | machine vision | industrial applications | particle imaging velocimetry (PIV) | spectroscopy | flow visualization (hydrodynamics) | industrial oem applications | fuel injection | material testing | luminescence spectroscopy | RED and NIR fluorescence applications | imaging of bio-markers (e.g. green fluorescent protein) | scintillation recording

You want to create your own application for the camera:

We offer a wide range of Software Development Kits (SDK) for different programming languages, both for windows and linux. Our pco.sdk, pco.recorder and high-level SDK are designed for C/C++ apps. With pco.python, pco.matlab, pco.labview and pco.java you can control the camera in your C#, python, matlab, labview and java applications, respectively. This camera is also gen<i>cam supported.

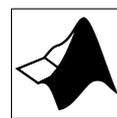
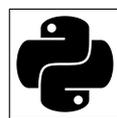
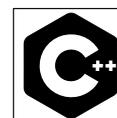
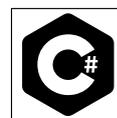
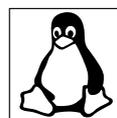
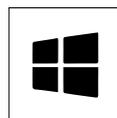

ordering information

pco.pixelfly 1.4 USB	85108015000	camera system, monochrome, 1392x1040 pixel, USB2
pco.pixelfly 1.4 C USB	85108015001	camera system, color, 1392x1040 pixel, USB2

pco.

An Excelitas Technologies Brand

postal address:	Excelitas PCO GmbH Donaupark 11 93309 Kelheim, Germany
telephone:	+49 (0) 9441 2005 0
e-mail:	pco@excelitas.com
web:	www.excelitas.com/pco



EXCELITAS
TECHNOLOGIES®