



SHENZHEN GUANGZHI BAO TECHNOLOGY CO., LTD.

CUSTOMER 客户: _____

承认规格书

SPECIFICATION FOR APPROVAL

规格型号: LBL050GDI 承认单位: _____

样品编号: _____ 客户反馈意见: _____

认定盖章Approval Cover Chapter		
核准	审核	制作

认定盖章Approval Cover Chapter			
核准	品管	工程	采购

地址: 深圳市南山区西丽街道松白路1055号丽河工业园6栋2楼

TEL: 0755-8398 3496

E-MAIL: lightbo@lightbo.cn

PART NO: LBL050GDI

Page: 1 of 4

Description: 5mm PURE GREEN Round LED

Package Dimensions:

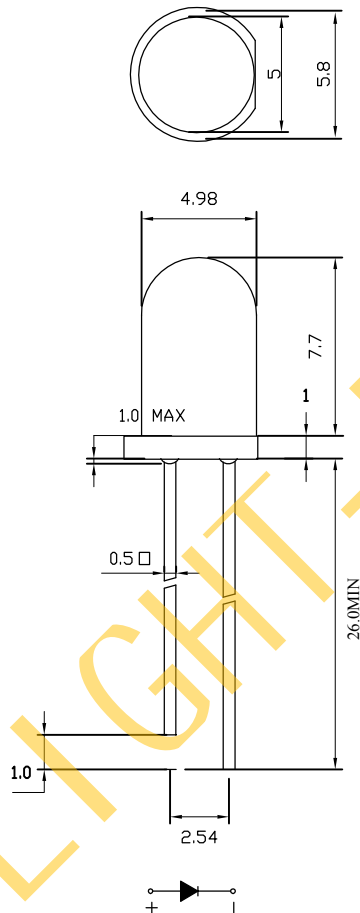

Lens 胶体颜色	Material 材质	Emitting Color 发光颜色
Green Diffused	IN. GA. N	PURE GREEN

NOTES

- 1.All dimensions are in millimeters .
- 2.Tolerance is $\pm 0.25\text{mm}$ unless otherwise noted.
- 3.Protruded resin under flange is 1.0mm max.
- 4.Lead spacing is measured where the leads emerge from the package.
- 5.Specifications are subject to change without notice.

Absolute Maximum Ratings at TA=25 °C

Parameter 参数名称	Maximum Rating	Unit
Power Dissipation 功耗	150	mW
Peak Forward Current (1/10 Duty Cycle,0.1ms Pulse Width) 瞬间脉冲电流	50	mA
DC Forward Current 正向电流	20	mA
Reverse Voltage 反向电压	5	V
Operating Temperature Range 正常使用温度	-20°C to+80°C	
Storage Temperature Range 贮藏温度	-40°C to+100°C	
Lead Soldering Temperature [1.6mm(.063") From Body] 焊接温度	300°C for 3seconds	

Electrical Optical Characteristics at TA=25 °C

Parameter 参数名称	Symbol	Min	Typ.	Max.	Unit	Test Condition
Luminous Intensity 发光亮度	Iv	20000		24000	mcd	IF=20mA
Viewing Angle 角度	2 θ 1/2		30°		deg	
Peak Emission Wavelength 峰值波长	λ p			510	nm	
Dominant Wavelength 标准波长	λ d	500			nm	IF=20mA
Spectral Line Half-Width 频谱半宽	Δ λ		30		nm	
Forward Voltage 正向电压	VF	2.8		3.0	V	IF=20mA
Reverse Current 反向漏电流	IR			10	μ A	VR=5V

- Note:**
1. Luminous intensity is measured with a light sensor and filter combination that approximates CIE (Commission International De L'Eclairage) eye-response curve.
 2. θ 1/2 is the off-axis angle at which the luminous intensity is half the axial luminous intensity.
 3. The dominant wavelength, λ d is derived from the CIE chromaticity diagram and represents the single wavelength which defines the color of the device.
 4. The Iv guarantee should be added ± 15%.

Typical Electrical / Optical Characteristics Curves (25° C Ambient Temperature Unless Otherwise Noted)

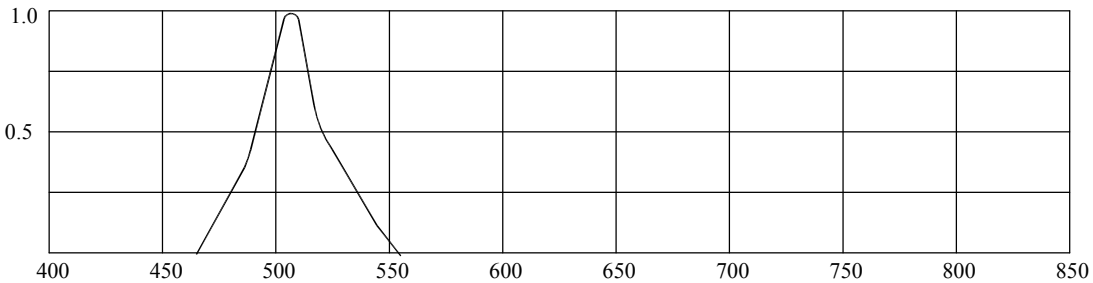

Wavelength λ (nm) 光谱分布图
Fig. 1 Relative Intensity vs . Wavelength

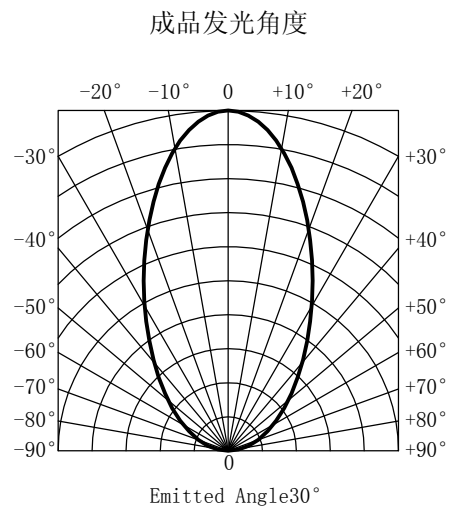
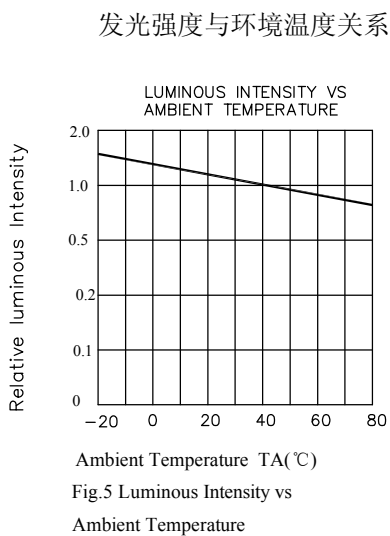
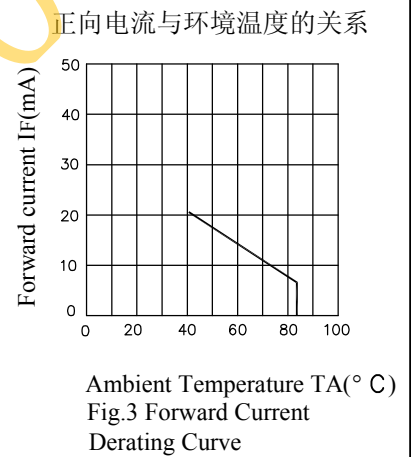
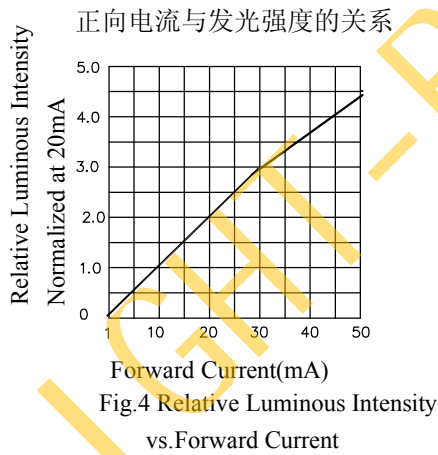
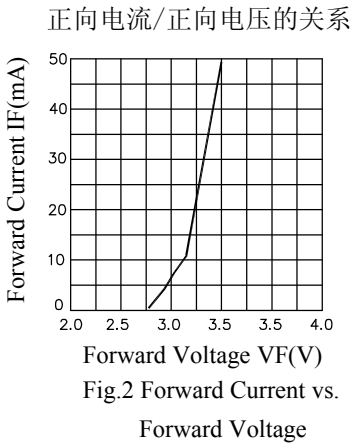

CAUTIONS

1.Application

The LEDs described here are intended to be used for ordinary electronic equipment (such as office equipment, communication equipment and household applications). Consult S L,s Sales in advance for information on applications in which exceptional reliability is required, particularly when the failure or malfunction of the LEDs may directly jeopardize life or health (such as in aviation ,transportation, traffic control equipment, medical and life support systems and safety devices)

2.Storage

The storage ambient for the LEDs should not exceed 30° C temperature or 70% relative humidity. It is recommended that LEDs out of their original packaging are used within three months. For extended storage out of their original packaging, it is recommended that the LEDs be stored in a sealed container with appropriate desiccant or in desiccators with nitrogen ambient.

3. Cleaning

Use alcohol-based cleaing solvent such as isopropyl alcohol to clean the LEDs if necessary.

4.Lead Forming & Assembly

During lead froming, the leads shold be bent at point at least 3mm from the base of LED lens. Do not use the base of the lead frame as a fulcrum during forming. Lead forming must be done before soldering, at normal temperature. During assembly on PCB, use minimum clinch force possible to avoid excessive mechanical stress.

5.Soldering

When soldering leave a minimum of 2mm clearance from the base of the lens to the soldering point. Dipping the lens into the solder must be avoided. Do not apply any external stress to the lead frame during soldering while the LED is at high temperature.

Recommended soldering conditions:

Soldering iron		Wave soldering	
Temperature	320°C Max	Pre-heat	100° C Max
Soldering time	3 sec.Max (one time only)	Pre-heat time	60sec.Max
		Solder wave	260° C Max
		Soldering time	10sec.Max

Note:Excessive soldering temperature and/or time might result in deformation of the LED lens or catastrophic failure of the LED.

6.Drive Method

An LED is a current-operated device, In order to ensure intenity uniformity on multiple LEDs connected in parallel in an application, it is recommended that a current limiting resistor be incorporated in the drive circuit, in series with each LED as shown in Circuit A below.

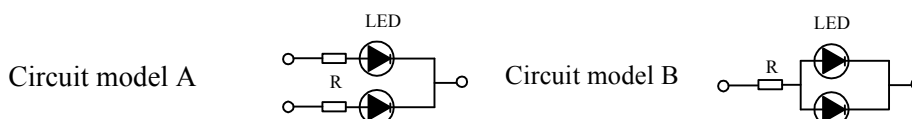

(A)Recommended circuit

(B)The brightness of each LED might appear different due to the differences in the I-V characteristics of those LEDs.

7.Protece Of ESD

Since the device is static sensitive, it is recommended that anti-static measures should be taken on human body, all devices (including soldering iron) and equipment, machinery, desk and ground.