

TLV3011, TLV3012, TLV3011B and TLV3012B Low-Power Comparators With Integrated 1.24 V Voltage Reference

1 Features

- Low quiescent current: 3.1 μA (maximum, "B" version)
- Integrated voltage reference: 1.242 V
- Input common-mode range: 200 mV beyond rails
- Voltage reference initial accuracy: 1%
- Fail-safe inputs ("B" version)
- Power-on-reset ("B" version)
- Integrated hysteresis ("B" version)
- Open drain output option (TLV3011x)
- Push-pull output option (TLV3012x)
- Fast response time: 6 μs
- Low supply voltage = 1.65 V to 5.5 V ("B" version)

2 Applications

- [Lane departure warning](#)
- [Cluster](#)
- [Toll tag](#)
- [Asset tracking](#)
- [Battery management systems](#)

3 Description

The TLV3011 is a low-power, open-drain output comparator; the TLV3012 is a push-pull output comparator. Both devices feature an uncommitted on-chip voltage reference and have a 5 μA (maximum) quiescent current, an input common-mode range 200 mV beyond the supply rails, and single-supply operation from 1.8 V to 5.5 V. The integrated 1.242 V series voltage reference offers low 100 ppm/ $^{\circ}\text{C}$ (maximum) drift, is stable with up to 10 nF capacitive load, and can provide up to 0.5 mA (typical) of output current.

The TLV3011B and TLV3012B "B" versions add power-on-reset (POR), fail-safe inputs, built-in hysteresis, a lower minimum supply voltage of 1.65 V and a 3.1 μA maximum quiescent current.

The family is available in both the tiny SOT23-6 package for space-conservative designs, and in the SC-70 package for even greater board area savings. All versions are specified for the temperature range of -40°C to $+125^{\circ}\text{C}$.

Device Information

| PART NUMBER | PACKAGE (1) | BODY SIZE (NOM) |
|--------------------------------------|-------------|--------------------------|
| TLV3011, TLV3012, TLV3011B, TLV3012B | SOT-23 (6) | 2.90 mm \times 1.60 mm |
| | SC-70 (6) | 2.00 mm \times 1.25 mm |

(1) For all available packages, see the orderable addendum at the end of the data sheet.

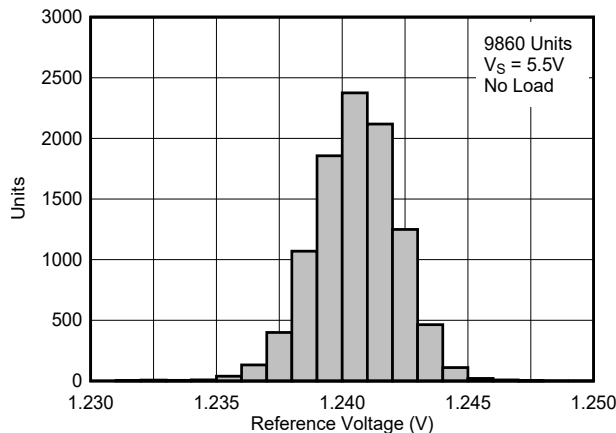

TLV3012B Reference Voltage Distribution

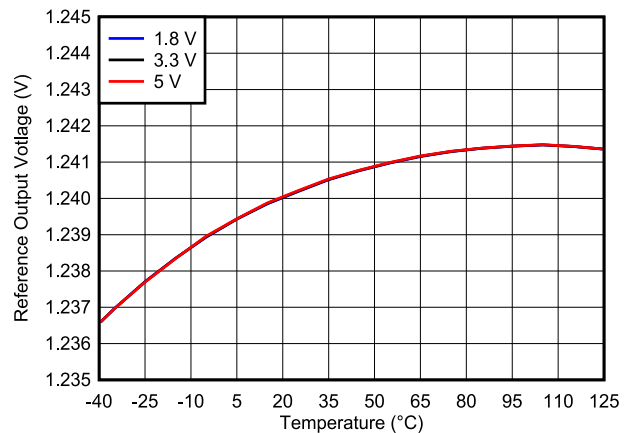

TLV3012B Reference Voltage vs Temperature



Table of Contents

| | | | |
|--|-----------|--|-----------|
| 1 Features | 1 | 7 Typical Characteristics - TLV3011 and TLV3012 | 11 |
| 2 Applications | 1 | 8 Typical Characteristics - TLV3011B and TLV3012B | 15 |
| 3 Description | 1 | 9 Detailed Description | 21 |
| 4 Revision History | 2 | 9.1 Overview..... | 21 |
| 5 Pin Configuration and Functions | 3 | 9.2 Functional Block Diagram..... | 21 |
| 6 Specifications | 4 | 9.3 Feature Description..... | 21 |
| 6.1 Absolute Maximum Ratings- TLV3011 and TLV3012 | 4 | 9.4 Device Functional Modes..... | 21 |
| 6.2 Absolute Maximum Ratings - TLV3011B and TLV3012B | 4 | 10 Application and Implementation | 23 |
| 6.3 ESD Ratings..... | 4 | 10.1 Application Information..... | 23 |
| 6.4 Thermal Information - TLV3011 and TLV3012..... | 5 | 10.2 Typical Application..... | 24 |
| 6.5 Thermal Information- TLV3011B and TLV3012B | 5 | 10.3 System Examples..... | 26 |
| 6.6 Recommended Operating Conditions..... | 5 | 10.4 Power Supply Recommendations..... | 27 |
| 6.7 Electrical Characteristics - TLV3011 and TLV3012 | 6 | 10.5 Layout..... | 27 |
| 6.8 Switching Characteristics - TLV3011 and TLV3012 | 7 | 11 Device and Documentation Support | 29 |
| 6.9 Electrical Characteristics - TLV3011B and TLV3012B | 8 | 11.1 Receiving Notification of Documentation Updates.. | 29 |
| 6.10 Switching Characteristics - TLV3011B and TLV3012B | 10 | 11.2 Support Resources..... | 29 |
| | | 11.3 Trademarks..... | 29 |
| | | 11.4 Electrostatic Discharge Caution..... | 29 |
| | | 11.5 Glossary..... | 29 |
| | | 12 Mechanical, Packaging, and Orderable Information | 29 |

4 Revision History

NOTE: Page numbers for previous revisions may differ from page numbers in the current version.

| Changes from Revision B (June 2004) to Revision C (April 2023) | Page |
|---|-------------|
| • Converted to TI format. Added <i>Pin Configuration and Functions</i> section, <i>ESD Ratings</i> table, <i>Feature Description</i> section, <i>Device Functional Modes</i> , <i>Application and Implementation</i> section, <i>Power Supply Recommendations</i> section, <i>Layout</i> section, <i>Device and Documentation Support</i> section, and <i>Mechanical, Packaging, and Orderable Information</i> section..... | 1 |
| • Added "B" version to front page text. Added "B" tables and graphs. Updated Apps Info for "B" devices..... | 1 |
| <hr/> | |
| Changes from Revision A (May 2004) to Revision B (June 2004) | Page |
| • Removed redundant pinouts on front page..... | 1 |
| <hr/> | |
| Changes from Revision * (February 2004) to Revision A (May 2004) | Page |
| • Changed the <i>Applications</i> list..... | 1 |
| • Added SC-70 package..... | 1 |
| • Removed redundant ordering information table - see ordering addendum at end of datasheet..... | 1 |
| • Deleted the <i>Package Ordering Information</i> section..... | 3 |

5 Pin Configuration and Functions

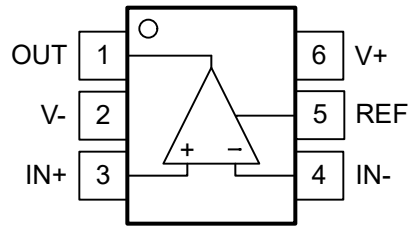

**Figure 5-1. DCK, DBV Package
6-Pin SC-70, SOT-23
Top View**

Table 5-1. Pin Functions

| PIN | | I/O | DESCRIPTION |
|-----|------|-----|---------------------------------|
| NO. | NAME | | |
| 1 | OUT | O | Comparator Output |
| 2 | V- | - | Negative (lowest) power supply |
| 3 | IN+ | I | Non-inverting comparator input |
| 4 | IN- | I | Inverting comparator input |
| 5 | REF | O | Reference Output |
| 6 | V+ | - | Positive (highest) power supply |

6 Specifications

6.1 Absolute Maximum Ratings- TLV3011 and TLV3012

Over operating free-air temperature range (unless otherwise noted)⁽¹⁾.

| | | MIN | MAX | UNIT |
|-------------------------------------|------------------------|------------|-----------|------|
| Supply voltage | | | 7 | V |
| Signal input pins | Voltage ⁽²⁾ | -0.5 | (V+) +0.5 | V |
| | Current ⁽²⁾ | | ±10 | mA |
| Output short circuit ⁽³⁾ | | Continuous | | |
| Operating temperature | | -40 | 125 | °C |
| T _J | Junction temperature | | 150 | °C |
| T _{stg} | Storage temperature | -65 | 150 | °C |

- (1) Stresses beyond those listed under *Absolute Maximum Ratings* may cause permanent damage to the device. These are stress ratings only, which do not imply functional operation of the device at these or any other conditions beyond those indicated under *Recommended Operating Conditions*. Exposure to absolute-maximum-rated conditions for extended periods may affect device reliability.
- (2) All voltage values are with respect to the network ground pin.
- (3) Short circuit to ground

6.2 Absolute Maximum Ratings - TLV3011B and TLV3012B

over operating free-air temperature range (unless otherwise noted)⁽¹⁾

| | | MIN | MAX | UNIT |
|--|--|------|------------|------|
| Supply voltage: V _S = (V+) – (V-) | | -0.5 | 7 | V |
| Input pins (IN+, IN-) from (V-) ⁽²⁾ | | -0.5 | 7 | V |
| Output (OUT) (Open-Drain) from (V-) ⁽³⁾ | | -0.5 | 7 | V |
| Output (OUT) (Push-Pull) from (V-) | | -0.5 | (V+) + 0.5 | V |
| Output short circuit current ⁽⁴⁾ | | | 10 | mA |
| Junction temperature, T _J | | | 150 | °C |
| Storage temperature, T _{stg} | | -65 | 150 | °C |

- (1) Operation outside the Absolute Maximum Ratings may cause permanent device damage. Absolute Maximum Ratings do not imply functional operation of the device at these or any other conditions beyond those listed under Recommended Operating Conditions. If used outside the Recommended Operating Conditions but within the Absolute Maximum Ratings, the device may not be fully functional, and this may affect device reliability, functionality, performance, and shorten the device lifetime.
- (2) Input pins are diode-clamped to (V-). Inputs (IN+, IN-) can be greater than (V+) as long as within the -0.5 V to 7 V range. Inputs beyond -0.3 V must be current-limited to less than -10 mA, while inputs beyond 7 V must be externally voltage clamped.
- (3) Output (OUT) for open drain can be greater than (V+) and inputs (IN+, IN-) as long as it is within the -0.5 V to 7 V range
- (4) Short-circuit to (V-) or (V+).

6.3 ESD Ratings

| | | VALUE | UNIT |
|--------------------|-------------------------|---|-------|
| V _(ESD) | Electrostatic discharge | Human-body model (HBM), per ANSI/ESDA/JEDEC JS-001 ⁽¹⁾ | ±2000 |
| | | Charged-device model (CDM), per ANSI/ESDA/JEDEC JS-002 ⁽²⁾ | ±1000 |

- (1) JEDEC document JEP155 states that 500 V HBM allows safe manufacturing with a standard ESD control process.
- (2) JEDEC document JEP157 states that 250 V CDM allows safe manufacturing with a standard ESD control process.

6.4 Thermal Information - TLV3011 and TLV3012

| THERMAL METRIC ⁽¹⁾ | | TLV3011, TLV3012 | | UNIT |
|-------------------------------|--|------------------|--------------|------|
| | | DCK (SC-70) | DBV (SOT-23) | |
| | | 6 PINS | 6 PINS | |
| R _{θJA} | Junction-to-ambient thermal resistance | 179.4 | 191.6 | °C/W |
| R _{θJC(top)} | Junction-to-case (top) thermal resistance | 141.3 | 123.9 | °C/W |
| R _{θJB} | Junction-to-board thermal resistance | 71.2 | 38.7 | °C/W |
| Ψ _{JT} | Junction-to-top characterization parameter | 53.6 | 21.2 | °C/W |
| Ψ _{JB} | Junction-to-board characterization parameter | 71.0 | 38.2 | °C/W |
| R _{θJC(bot)} | Junction-to-case (bottom) thermal resistance | - | - | °C/W |

(1) For more information about traditional and new thermal metrics, see the [Semiconductor and IC Package Thermal Metrics](#) application report.

6.5 Thermal Information- TLV3011B and TLV3012B

| THERMAL METRIC ⁽¹⁾ | | TLV3011B, TLV3012B | | UNIT |
|-------------------------------|--|--------------------|--------------|------|
| | | DCK (SC-70) | DBV (SOT-23) | |
| | | 6 PINS | 6 PINS | |
| R _{θJA} | Junction-to-ambient thermal resistance | 169.8 | 162.5 | °C/W |
| R _{θJC(top)} | Junction-to-case (top) thermal resistance | 120.5 | 78.8 | °C/W |
| R _{θJB} | Junction-to-board thermal resistance | 63.2 | 42.1 | °C/W |
| Ψ _{JT} | Junction-to-top characterization parameter | 45.9 | 21.2 | °C/W |
| Ψ _{JB} | Junction-to-board characterization parameter | 63.0 | 41.9 | °C/W |
| R _{θJC(bot)} | Junction-to-case (bottom) thermal resistance | - | - | °C/W |

(1) For more information about traditional and new thermal metrics, see the [Semiconductor and IC Package Thermal Metrics](#) report.

6.6 Recommended Operating Conditions

over operating free-air temperature range (unless otherwise noted)

| | | MIN | MAX | UNIT |
|---|------------|------|------------|------|
| Supply voltage: V _S = (V+) – (V–) | | 1.8 | 5.5 | V |
| Supply voltage: V _S = (V+) – (V–) | B-Versions | 1.65 | 5.5 | V |
| Input voltage range from (V–) | | –0.2 | (V+) + 0.2 | V |
| Output voltage range from (V–) for open drain | | –0.2 | (V+) | V |
| Output voltage range from (V–) for open drain | B-Versions | –0.2 | 5.5 | V |
| Ambient temperature, T _A | | –40 | 125 | °C |

6.7 Electrical Characteristics - TLV3011 and TLV3012

$V_S = 1.8\text{ V to }5.5\text{ V}$, at $T_A = 25^\circ\text{C}$, $V_{OUT} = V_S$, unless otherwise noted

| PARAMETER | | TEST CONDITIONS | MIN | TYP | MAX | UNIT |
|----------------------------|-------------------------------------|---|---------------|-----------------------------|---------------|------------------------------|
| OFFSET VOLTAGE | | | | | | |
| V_{OS} | Input offset voltage | $V_{CM} = 0\text{ V}$, $I_O = 0\text{ V}$ | | 0.5 | 15 | mV |
| dV_{OS}/dT | Input offset voltage vs temperature | $T_A = -40^\circ\text{C to }+125^\circ\text{C}$ | | ± 12 | | $\mu\text{V}/^\circ\text{C}$ |
| PSRR | Power supply rejection ratio | $V_S = 1.8\text{ V to }5.5\text{ V}$ | | 100 | 1000 | $\mu\text{V}/\text{V}$ |
| INPUT BIAS CURRENT | | | | | | |
| I_B | Input bias current | $V_{CM} = V_S/2$ | | ± 10 | | μA |
| I_{OS} | Input offset current | $V_{CM} = V_S/2$ | | ± 10 | | μA |
| INPUT VOLTAGE RANGE | | | | | | |
| V_{CM} | Common-mode voltage range | | $(V_-) - 0.2$ | | $(V_+) + 0.2$ | V |
| CMRR | Common-mode rejection ratio | $V_{CM} = -0.2\text{ V to } (V_+) - 1.5\text{ V}$ | 60 | 74 | | dB |
| | | $V_{CM} = -0.2\text{ V to } (V_+) + 0.2\text{ V}$ | 54 | 62 | | |
| INPUT IMPEDANCE | | | | | | |
| | Common mode | | | $10^{13} \parallel 2$ | | $\Omega \parallel \text{pF}$ |
| | Differential | | | $10^{13} \parallel 4$ | | $\Omega \parallel \text{pF}$ |
| OUTPUT | | | | | | |
| V_{OL} | Voltage output low from rail | $V_S = 5\text{ V}$, $I_{OUT} = -5\text{ mA}$ | | 160 | 200 | mV |
| V_{OH} | Voltage output high from rail | $V_S = 5\text{ V}$, $I_{OUT} = 5\text{ mA}$ | | 90 | 200 | mV |
| | Short-circuit current | | | See Typical Characteristics | | |
| VOLTAGE REFERENCE | | | | | | |
| V_{OUT} | Output voltage | | 1.208 | 1.242 | 1.276 | V |
| | Initial accuracy | | | | $\pm 1\%$ | |
| dV_{OUT}/dT | Temperature drift | $-40^\circ\text{C} \leq T_A \leq 125^\circ\text{C}$ | | 40 | 100 | $\text{ppm}/^\circ\text{C}$ |
| dV_{OUT}/dI_{LOAD} | Load regulation, sourcing | $0\text{ mA} < I_{SOURCE} \leq 0.5\text{ mA}$ | | 0.36 | 1 | mV/mA |
| | Load regulation, sinking | $0\text{ mA} < I_{SINK} \leq 0.5\text{ mA}$ | | 6.6 | | |
| I_{LOAD} | Output current | | | 0.5 | | mA |
| dV_{OUT}/dV_{IN} | Line regulation | $1.8\text{ V} \leq V_{IN} \leq 5.5\text{ V}$ | | 10 | 100 | $\mu\text{V}/\text{V}$ |
| NOISE | | | | | | |
| | Reference voltage noise | $f = 0.1\text{ Hz to }10\text{ Hz}$ | | 0.2 | | mV_{PP} |
| POWER SUPPLY | | | | | | |
| V_S | Specified voltage | | 1.8 | | 5.5 | V |
| | Operating voltage range | | 1.8 | | 5.5 | V |
| I_Q | Quiescent current | $V_S = 5\text{ V}$, $V_O = \text{High}$ | | 2.8 | 5 | μA |
| TEMPERATURE | | | | | | |
| | Operating range | | -40 | | 125 | $^\circ\text{C}$ |
| | Storage range | | -65 | | 150 | $^\circ\text{C}$ |

6.8 Switching Characteristics - TLV3011 and TLV3012

over operating free-air temperature range (unless otherwise noted)

| PARAMETER | TEST CONDITIONS | MIN | TYP | MAX | UNIT |
|-------------------------------------|--|-----|------|-----|------|
| Propagation delay time, low to high | f = 10 kHz, V _{STEP} = 1 V, input overdrive = 10 mV | | 12 | | μs |
| | f = 10 kHz, V _{STEP} = 1 V, input overdrive = 100 mV | | 6 | | |
| Propagation delay time, high to low | f = 10 kHz, V _{STEP} = 1 V, input overdrive = 10 mV | | 13.5 | | μs |
| | f = 10 kHz, V _{STEP} = 1 V, input overdrive = 100 mV | | 6.5 | | |
| t _r Rise time | C _L = 10 pF | | 100 | | ns |
| t _f Fall time | C _L = 10 pF | | 100 | | ns |

6.9 Electrical Characteristics - TLV3011B and TLV3012B

For V_S (TOTAL SUPPLY VOLTAGE) = $(V+) - (V-) = 1.8V$ and $5.5V$, $V_{CM} = V_S/2$ at $T_A = 25^\circ C$ (Unless otherwise noted)

| PARAMETER | | TEST CONDITIONS | MIN | TYP | MAX | UNIT |
|--------------------------------|--|---|--------------------|-----------|--------------------|------------------|
| OFFSET VOLTAGE | | | | | | |
| V_{OS} | Input offset voltage | $V_{CM} = (V-)$ | -6 | ±0.3 | 6 | mV |
| V_{OS} | Input offset voltage | $V_{CM} = (V-)$ $T_A = -40^\circ C$ to $+125^\circ C$ | -9 | | 9 | mV |
| dV_{IO}/dT | Input offset voltage drift | $V_{CM} = (V-)$ $T_A = -40^\circ C$ to $+125^\circ C$ | | ±12 | | $\mu V/^\circ C$ |
| PSRR | power supply rejection ratio | $V_{CM} = (V-)$ $V_S = 1.65 V$ to $5.5 V$ $T_A = -40^\circ C$ to $+125^\circ C$ | | 100 | 1000 | $\mu V/V$ |
| V_{HYS} | Input hysteresis voltage | $T_A = -40^\circ C$ to $+125^\circ C$ | 2 | 6 | 8 | mV |
| INPUT BIAS CURRENT | | | | | | |
| I_B | Input bias current | $V_{CM} = V_S/2$ | -10 ⁽¹⁾ | ±4.5 | 10 ⁽¹⁾ | pA |
| I_{OS} | Input offset current | $V_{CM} = V_S/2$ | -10 ⁽¹⁾ | ±1 | 10 ⁽¹⁾ | pA |
| INPUT COMMON MODE RANGE | | | | | | |
| $V_{CM-Range}$ | Common-mode voltage range | $V_S = 1.8 V$ to $5.5 V$ | $(V-) - 0.2$ | | $(V+) + 0.2$ | V |
| CMRR | Common mode rejection ratio | $V_{CM} = (V-) + 1.5V$ to $(V+) + 0.2V$ $V_S = 5.5 V$ | 60 | 74 | | dB |
| CMRR | Common mode rejection ratio | $V_{CM} = (V-) - 0.2V$ to $(V+) + 0.2V$ $V_S = 5.5 V$ | 54 | 62 | | dB |
| R_{CM} | Input Common Mode Resistance | | | 10^{13} | | Ω |
| C_{IC} | Input Common Mode Capacitance | | | 2 | | pF |
| INPUT IMPEDANCE | | | | | | |
| R_{DM} | Input Differential Mode Resistance | | | 10^{13} | | Ω |
| C_{ID} | Input Differential Mode Capacitance | | | 4 | | pF |
| OUTPUT | | | | | | |
| V_{OL} | Voltage swing from $(V-)$ | $V_S = 5 V$ $I_{SINK} = 5 mA$ $T_A = -40^\circ C$ to $+125^\circ C$ | | 160 | 200 | mV |
| V_{OH} | Voltage swing from $(V+)$ (for Push-Pull only) | $V_S = 5 V$ $I_{SOURCE} = 5 mA$ $T_A = -40^\circ C$ to $+125^\circ C$ | | 90 | 200 | mV |
| VOLTAGE REFERENCE | | | | | | |
| V_{OUT} | Reference Voltage | | 1.223 | 1.242 | 1.260 | V |
| | Accuracy | | | ±0.25% | ±1.5% | |
| dV_{OUT}/dT | Temperature Drift | $T_A = -40^\circ C$ to $+125^\circ C$ | | 40 | 100 | ppm/ $^\circ C$ |
| dV_{OUT}/dI_{LOAD} | Load Regulation, Sourcing | $0 mA < I_{SOURCE} \leq 0.5 mA$ | | 0.36 | 1 ⁽¹⁾ | mV/mA |
| | Load Regulation, Sinking | $0 mA < I_{SINK} \leq 0.5 mA$ | | 6.6 | | mV/mA |
| I_{LOAD} | Output Current | | | 0.5 | | mA |
| dV_{OUT}/dV_S | Line Regulation | $1.65 V \leq V_S \leq 5.5 V$ | | 10 | 100 ⁽¹⁾ | $\mu V/V$ |
| V_{noise} | Noise | $f = 0.1 Hz$ to $10 Hz$ | | 0.2 | | mV _{PP} |

6.9 Electrical Characteristics - TLV3011B and TLV3012B (continued)

For V_S (TOTAL SUPPLY VOLTAGE) = (V+) – (V-) = 1.8V and 5.5V, $V_{CM} = V_S/2$ at $T_A = 25^\circ\text{C}$ (Unless otherwise noted)

| PARAMETER | | TEST CONDITIONS | MIN | TYP | MAX | UNIT |
|---------------------|----------------------------------|---|-----|-----|-----|---------------|
| POWER SUPPLY | | | | | | |
| I_Q | Quiescent current per comparator | Output is logic high | | 2.4 | 3.1 | μA |
| I_Q | Quiescent current per comparator | Output is logic high $T_A = -40^\circ\text{C}$ to $+125^\circ\text{C}$ | | | 3.6 | μA |

(1) Ensured by characterization

6.10 Switching Characteristics - TLV3011B and TLV3012B

For V_S (TOTAL SUPPLY VOLTAGE) = $(V+) - (V-) = 1.8\text{ V}$ and 5.5 V , $V_{CM} = V_S / 2$ at $T_A = 25^\circ\text{C}$ (Unless otherwise noted)

| PARAMETER | | TEST CONDITIONS | MIN | TYP | MAX | UNIT |
|---------------|--|---|-----|-----|-----|---------------|
| OUTPUT | | | | | | |
| T_{PD-LH} | Propagation delay time, low-to-high (push-pull output) | $f = 10\text{ kHz}$, $V_{STEP} = 200\text{mV}$, $V_{OD} = 100\text{ mV}$, $C_L = 10\text{ pF}$ | | 2 | 4 | μs |
| T_{PD-HL} | Propagation delay time, high-to-low | $f = 10\text{ kHz}$, $V_{STEP} = 200\text{mV}$, $V_{OD} = 100\text{ mV}$, $C_L = 10\text{ pF}$ | | 2 | 4 | μs |
| T_{RISE} | Output Rise Time, 20% to 80%, push-pull output | $C_L = 10\text{ pF}$ | | 10 | | ns |
| T_{FALL} | Output Fall Time, 80% to 20% | $C_L = 10\text{ pF}$ | | 10 | | ns |
| T_{FALL} | Output Fall Time, 80% to 20%, open-drain output | $R_L = 10\text{ k}\Omega$, $C_L = 10\text{ pF}$ | | 10 | | ns |
| t_{ON} | Power on-time | | | 1.9 | | ms |

7 Typical Characteristics - TLV3011 and TLV3012

At $T_A = 25^\circ\text{C}$, $V_S = 1.8\text{ V}$ to 5.5 V , and Input Overdrive = 100 mV , unless otherwise noted.

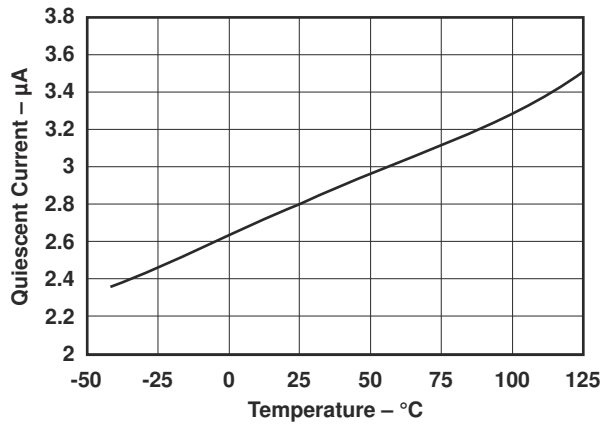

Figure 7-1. Quiescent Current vs Temperature

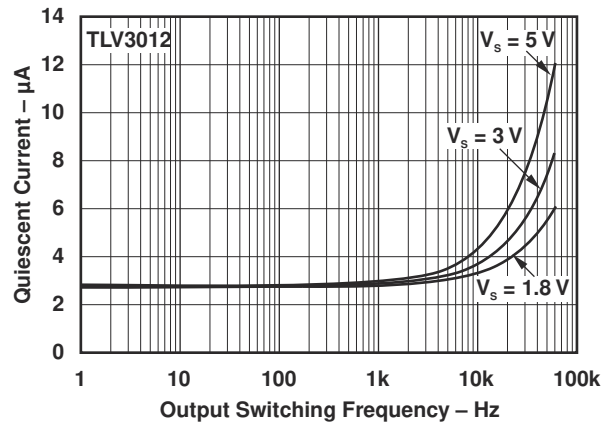

Figure 7-2. Quiescent Current vs Output Switching Frequency

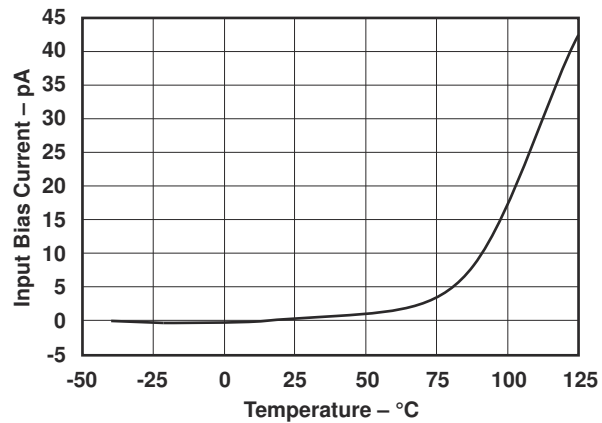

Figure 7-3. Input Bias Current vs Temperature

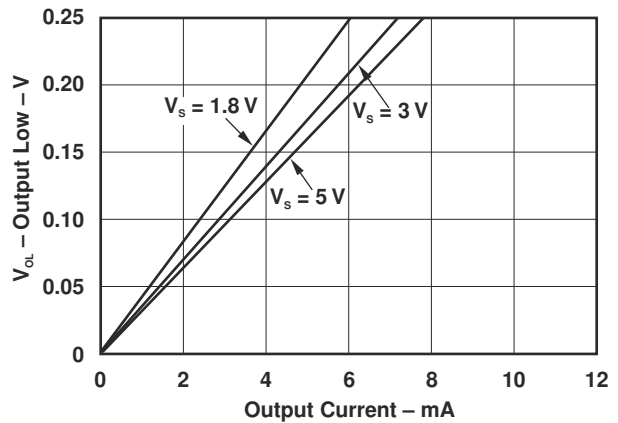

Figure 7-4. Output Low vs Output Current

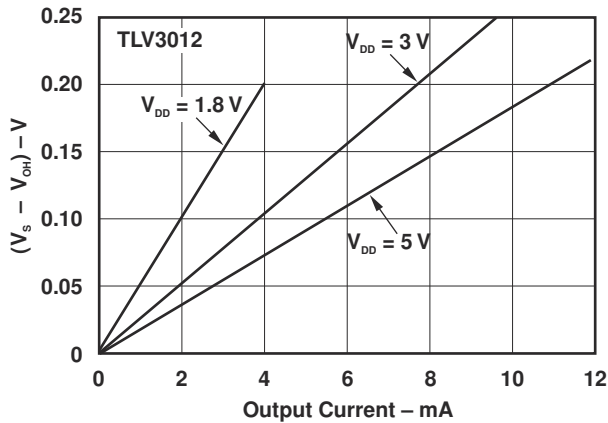

Figure 7-5. Output High vs Output Current

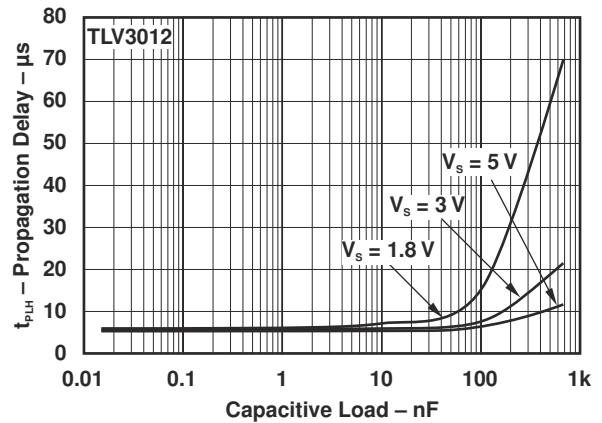

Figure 7-6. Propagation Delay (t_{PLH}) vs Capacitive Load

7 Typical Characteristics - TLV3011 and TLV3012 (continued)

At $T_A = 25^\circ\text{C}$, $V_S = 1.8\text{ V}$ to 5.5 V , and Input Overdrive = 100 mV , unless otherwise noted.

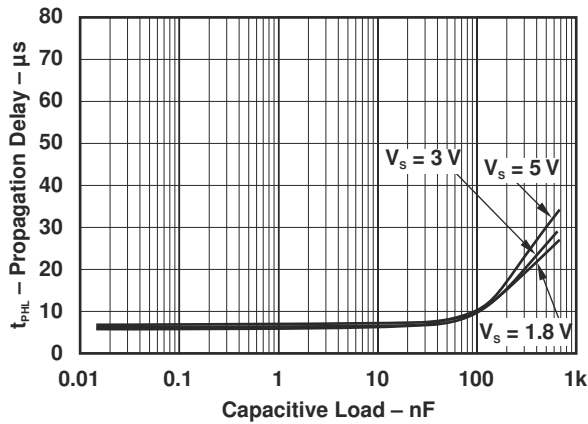

Figure 7-7. Propagation Delay (t_{pHL}) vs Capacitive Load

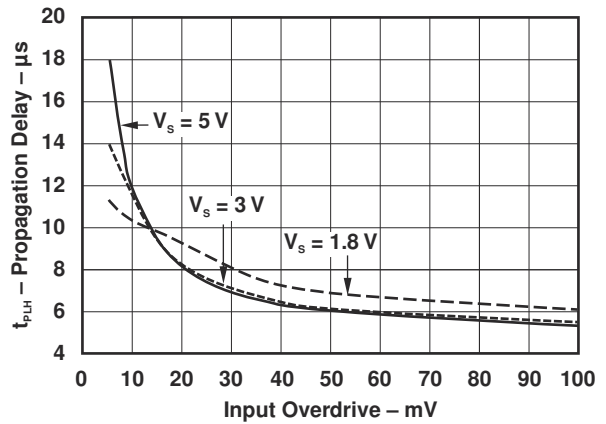

Figure 7-8. Propagation Delay (t_{pLH}) vs Input Overdrive

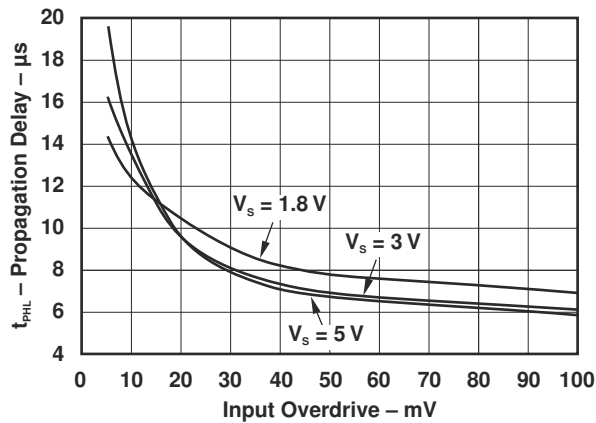

Figure 7-9. Propagation Delay (t_{pHL}) vs Input Overdrive

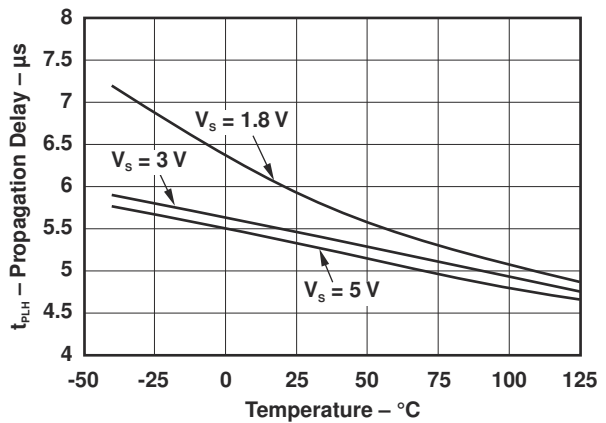

Figure 7-10. Propagation Delay (t_{pLH}) vs Temperature

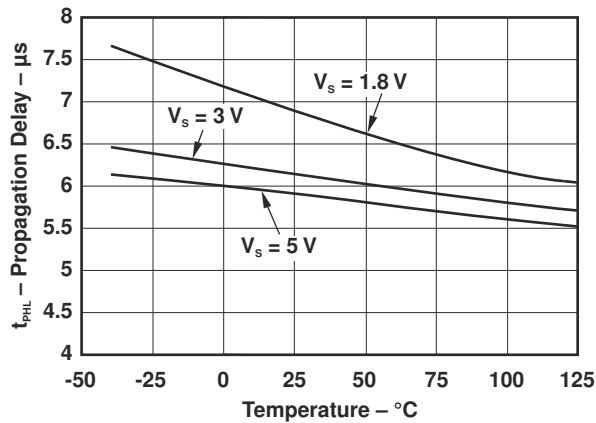

Figure 7-11. Propagation Delay (t_{pHL}) vs Temperature

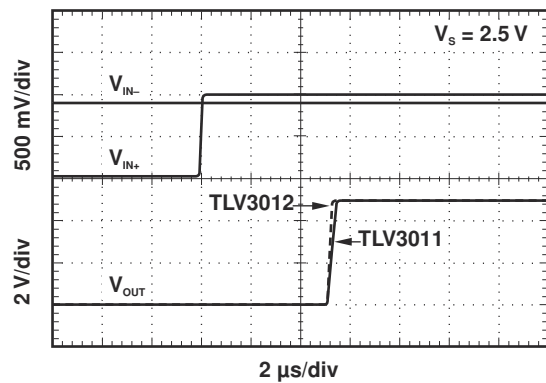

Figure 7-12. Propagation Delay (t_{pLH})

7 Typical Characteristics - TLV3011 and TLV3012 (continued)

At $T_A = 25^\circ\text{C}$, $V_S = 1.8\text{ V to }5.5\text{ V}$, and Input Overdrive = 100 mV, unless otherwise noted.

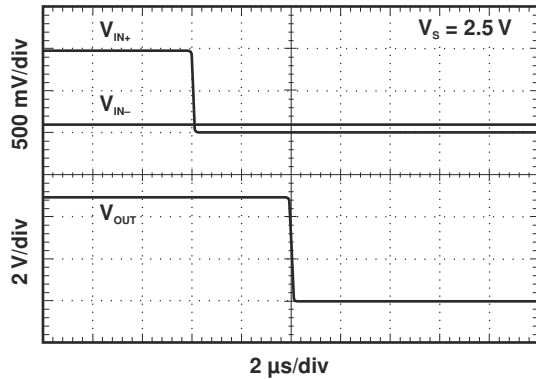

Figure 7-13. Propagation Delay (t_{PHL})

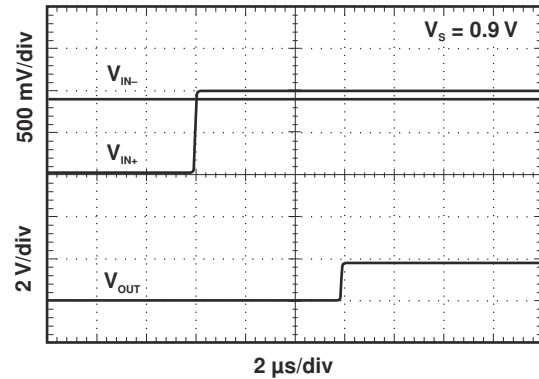

Figure 7-14. Propagation Delay (t_{PLH})

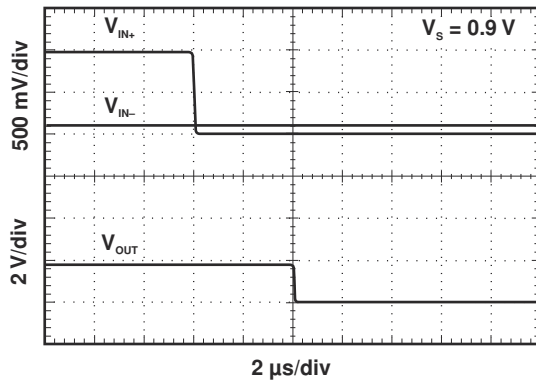

Figure 7-15. Propagation Delay (t_{PHL})

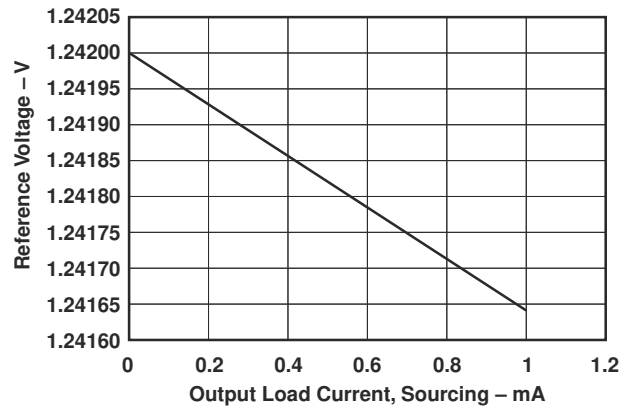

Figure 7-16. Reference Voltage vs Output Load Current (Sourcing)

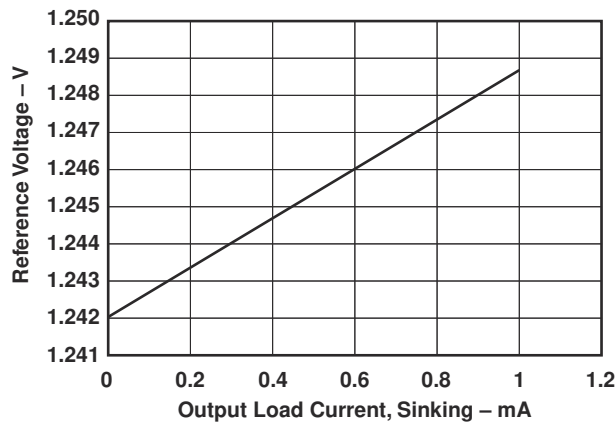

Figure 7-17. Reference Voltage vs Output Load Current (Sinking)

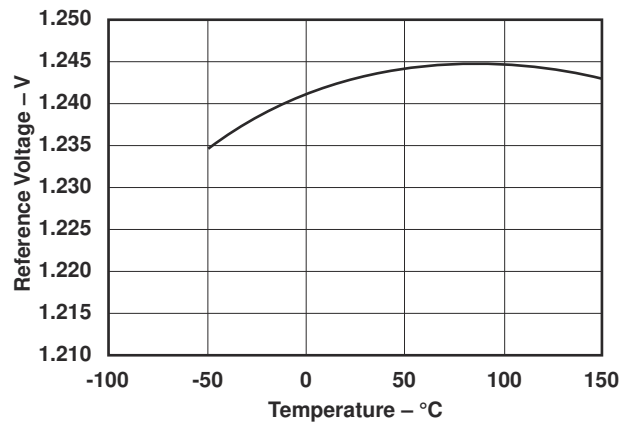

Figure 7-18. Reference Voltage vs Temperature

7 Typical Characteristics - TLV3011 and TLV3012 (continued)

At $T_A = 25^\circ\text{C}$, $V_S = 1.8\text{ V to }5.5\text{ V}$, and Input Overdrive = 100 mV, unless otherwise noted.

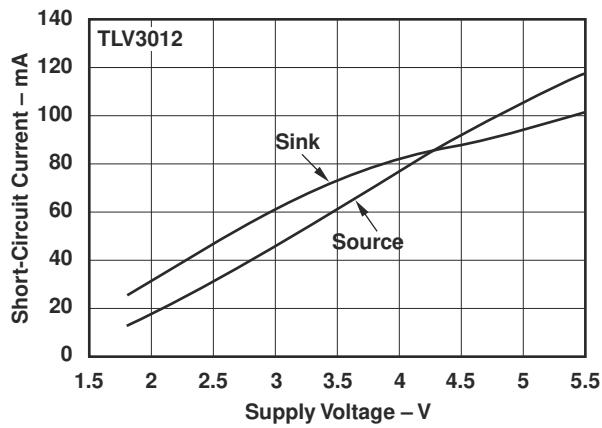

Figure 7-19. Short-Circuit Current vs Supply Voltage

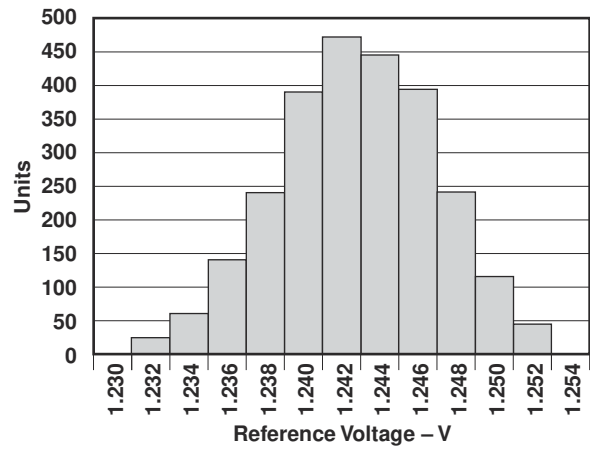

Figure 7-20. Reference Voltage Distribution

8 Typical Characteristics - TLV3011B and TLV3012B

For V_S (Total Supply Voltage) = $(V+) - (V-) = +5V$, $V_{CM} = V_S / 2$ at $T_A = 25^\circ C$, $R_{PULLUP} = 1M\Omega$ to $V+$, $C_L = 15pF$, $V_{OD} = 100mV$ unless otherwise noted.

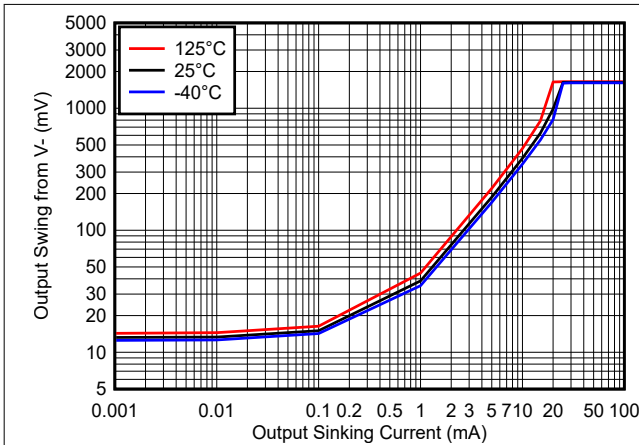

Figure 8-1. Output Swing vs. Output Sinking Current - 1.8V

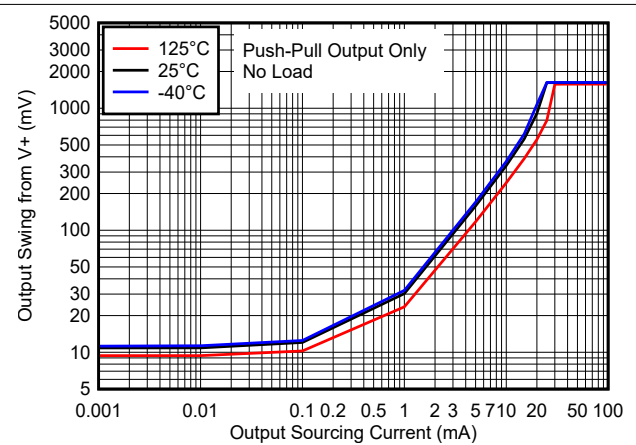

Figure 8-2. Output Swing vs. Output Sourcing Current - 1.8V

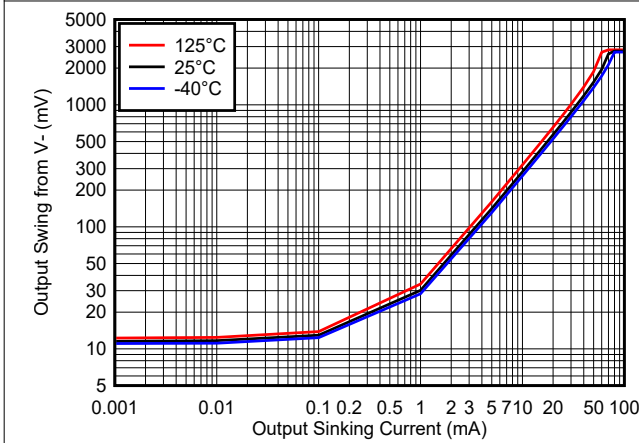

Figure 8-3. Output Swing vs. Output Sinking Current - 3.3V

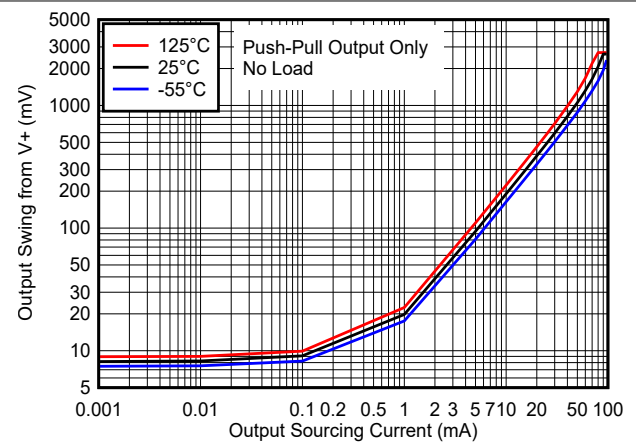

Figure 8-4. Output Swing vs. Output Sourcing Current - 3.3V

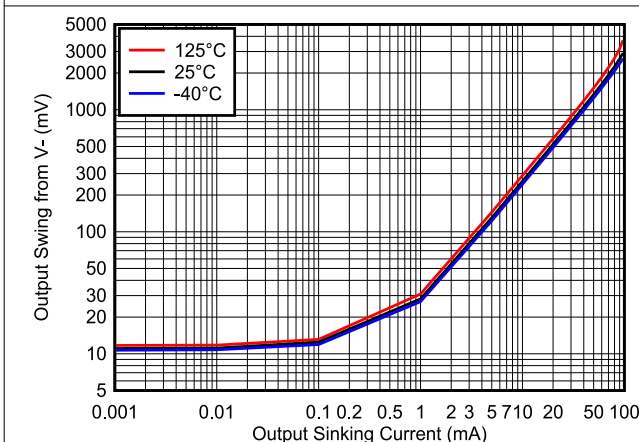

Figure 8-5. Output Swing vs. Output Sinking Current - 5V

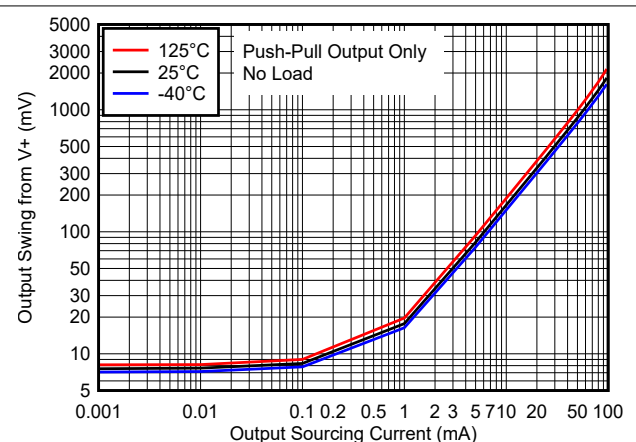

Figure 8-6. Output Swing vs. Output Sourcing Current - 5V

8 Typical Characteristics - TLV3011B and TLV3012B (continued)

For V_S (Total Supply Voltage) = $(V+) - (V-) = +5V$, $V_{CM} = V_S / 2$ at $T_A = 25^\circ C$, $R_{PULLUP} = 1M\Omega$ to $V+$, $C_L = 15pF$, $V_{OD} = 100mV$ unless otherwise noted.

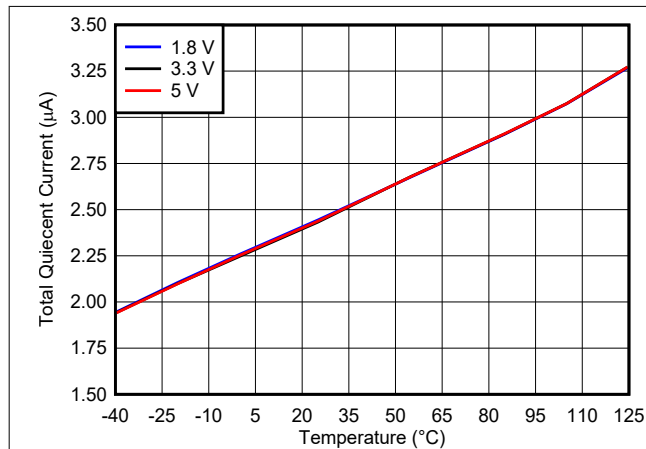

Figure 8-7. Supply Current vs. Temperature

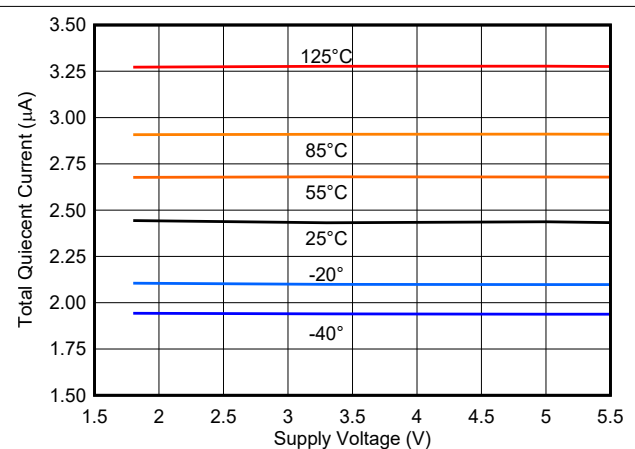

Figure 8-8. Supply Current vs. Supply Voltage

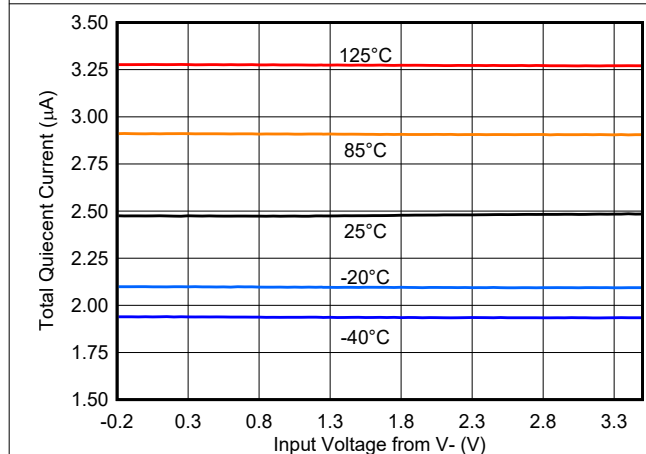

Figure 8-9. Supply Current vs. Common Mode - 3.3V

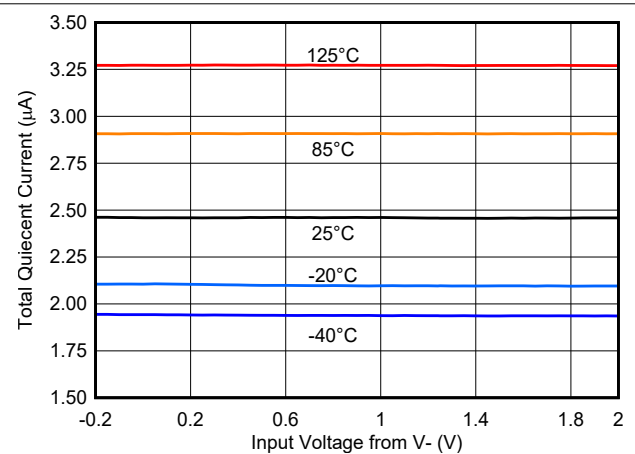

Figure 8-10. Supply Current vs. Common Mode - 1.8V

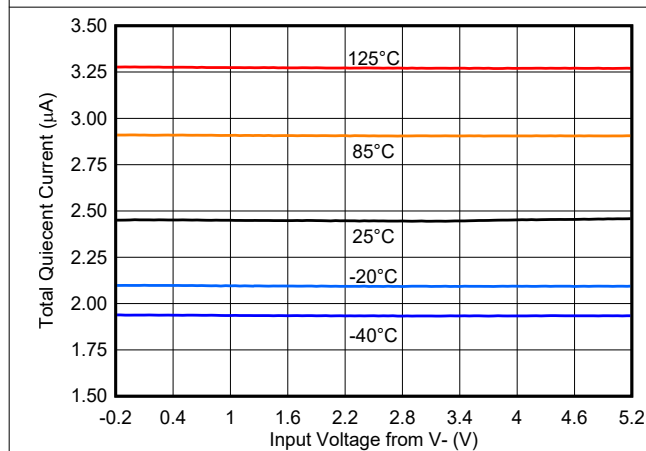

Figure 8-11. Supply Current vs. Common Mode - 5V

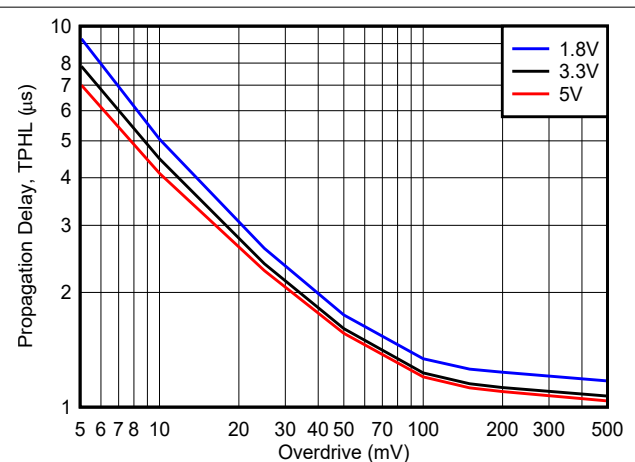

Figure 8-12. High to Low Propagation Delay vs. Overdrive

8 Typical Characteristics - TLV3011B and TLV3012B (continued)

For V_S (Total Supply Voltage) = $(V+) - (V-) = +5V$, $V_{CM} = V_S / 2$ at $T_A = 25^\circ C$, $R_{PULLUP} = 1M\Omega$ to $V+$, $C_L = 15pF$, $V_{OD} = 100mV$ unless otherwise noted.

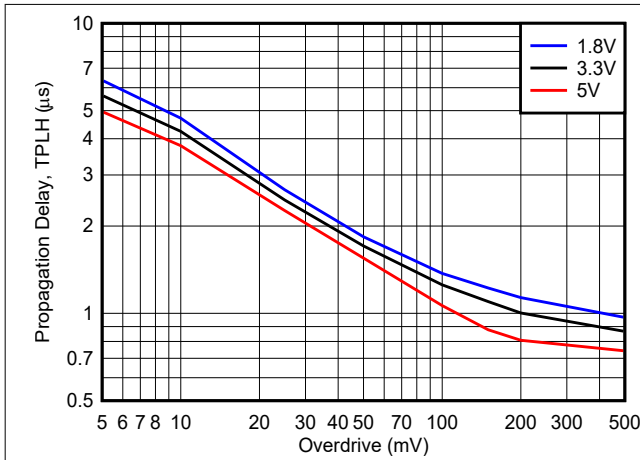

Figure 8-13. Low to High Propagation Delay vs. Overdrive

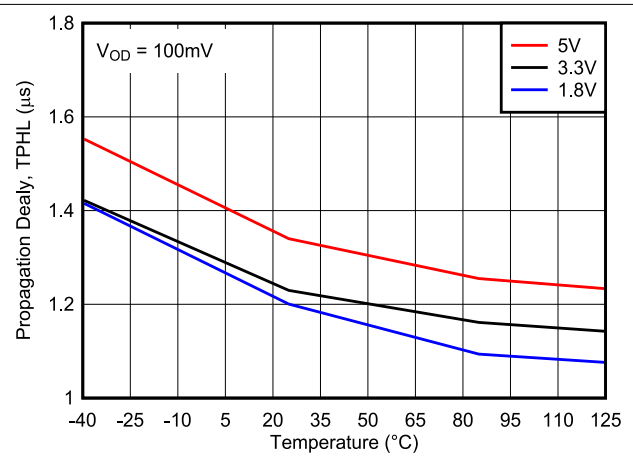

Figure 8-14. High to Low Propagation Delay vs. Temperature

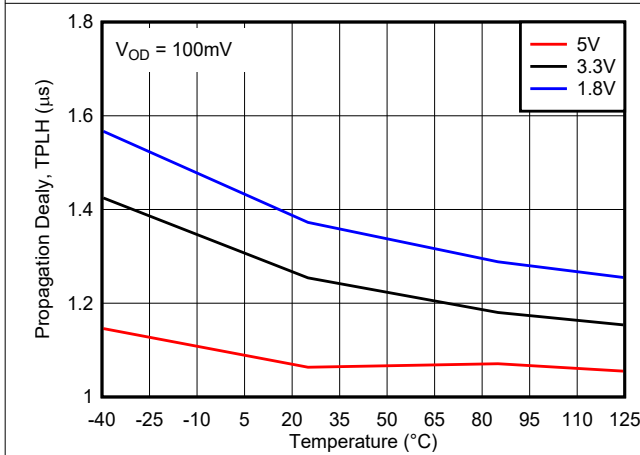

Figure 8-15. Low to High Propagation Delay vs. Temperature

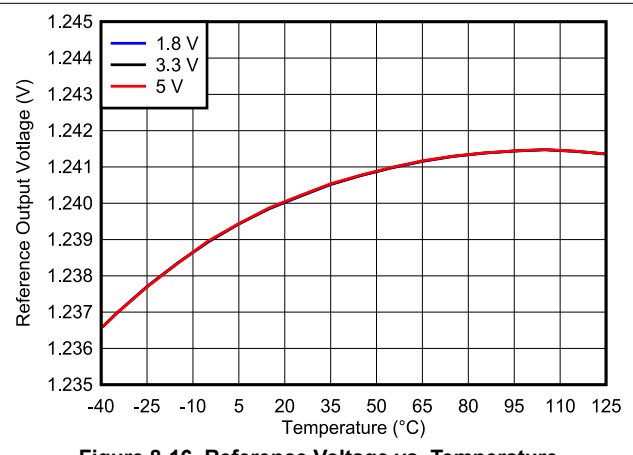

Figure 8-16. Reference Voltage vs. Temperature

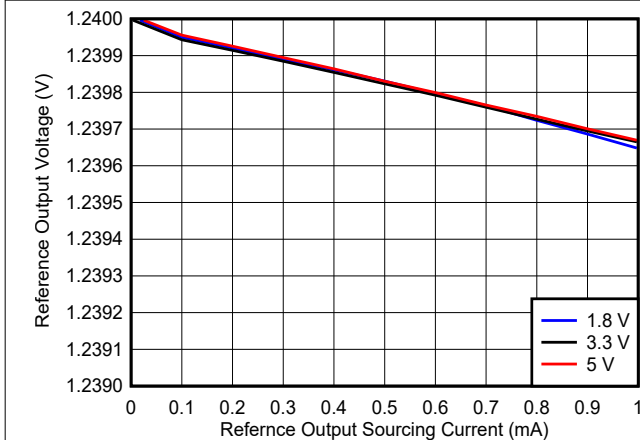

Figure 8-17. Reference Voltage vs. Reference Output Sourcing Current

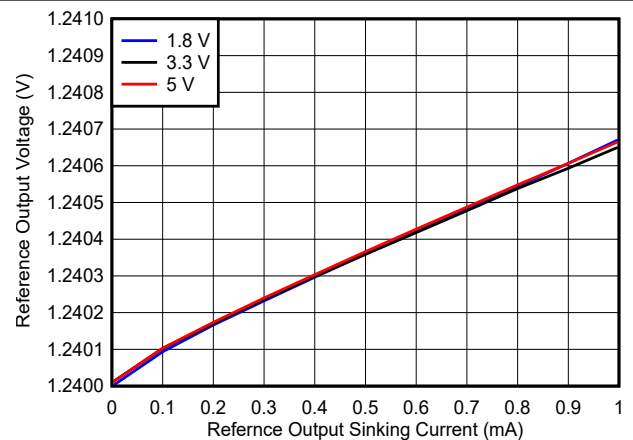

Figure 8-18. Reference Voltage vs. Reference Output Sinking Current

8 Typical Characteristics - TLV3011B and TLV3012B (continued)

For V_S (Total Supply Voltage) = $(V+) - (V-) = +5V$, $V_{CM} = V_S / 2$ at $T_A = 25^\circ C$, $R_{PULLUP} = 1M\Omega$ to $V+$, $C_L = 15pF$, $V_{OD} = 100mV$ unless otherwise noted.

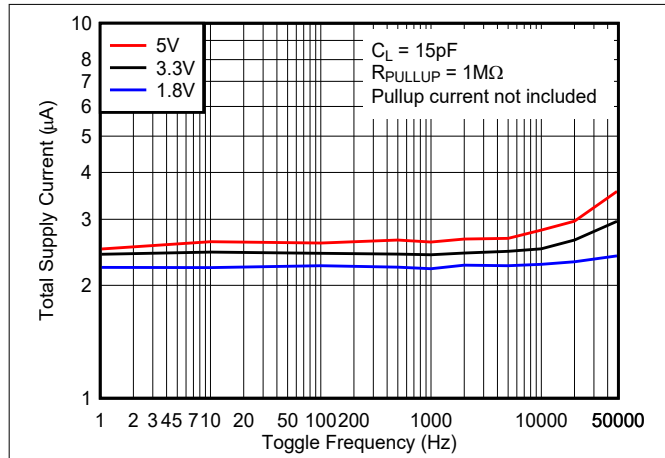

Figure 8-19. Supply Current vs. Toggle Frequency - Open Drain Output

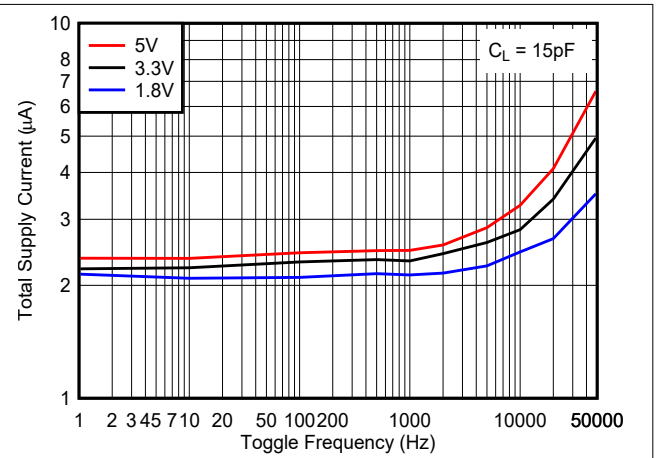

Figure 8-20. Supply Current vs. Toggle Frequency - Push-Pull Output

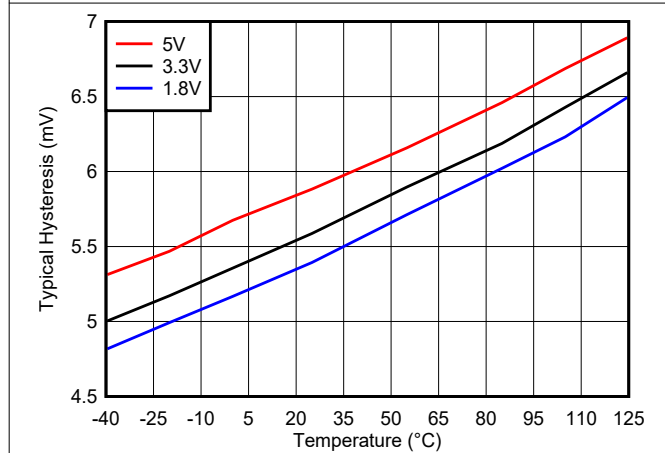

Figure 8-21. Hysteresis Voltage vs. Temperature

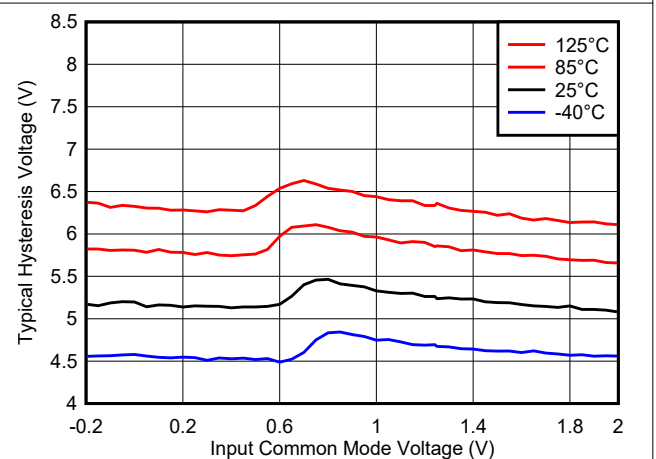

Figure 8-22. Hysteresis Voltage vs. Common Mode, 1.8V

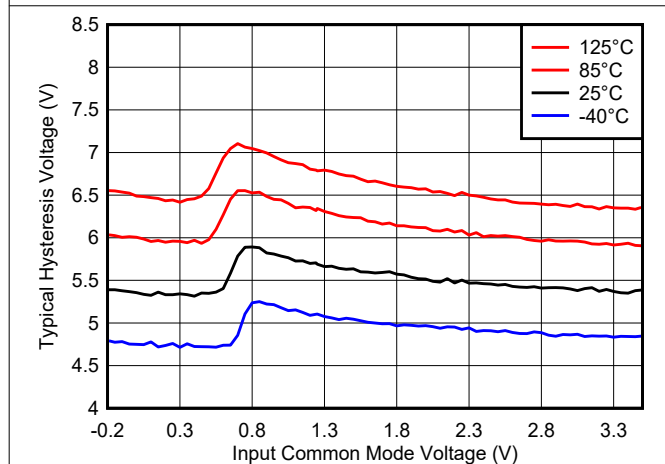

Figure 8-23. Hysteresis Voltage vs. Common Mode, 3.3V

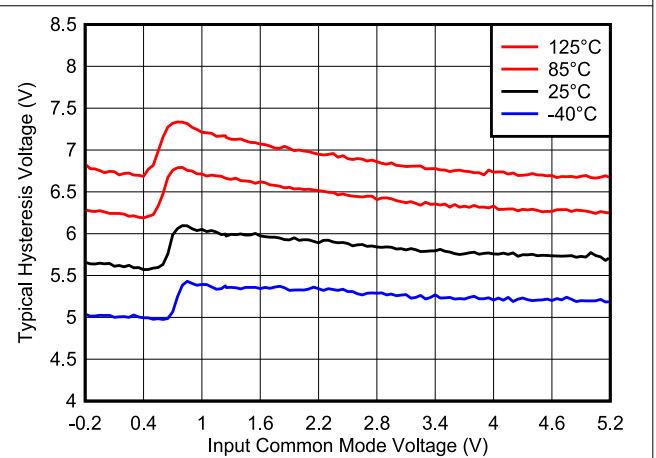

Figure 8-24. Hysteresis Voltage vs. Common Mode, 5V

8 Typical Characteristics - TLV3011B and TLV3012B (continued)

For V_S (Total Supply Voltage) = $(V+) - (V-) = +5V$, $V_{CM} = V_S / 2$ at $T_A = 25^\circ C$, $R_{PULLUP} = 1M\Omega$ to $V+$, $C_L = 15pF$, $V_{OD} = 100mV$ unless otherwise noted.

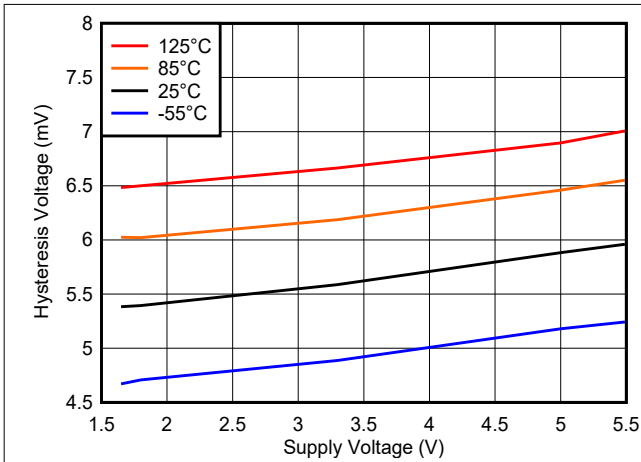

Figure 8-25. Hysteresis Voltage vs. Supply Voltage

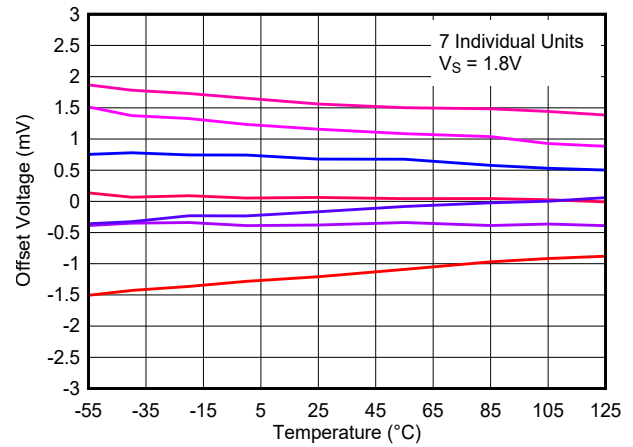

Figure 8-26. Offset Voltage vs. Temperature, 1.8 V

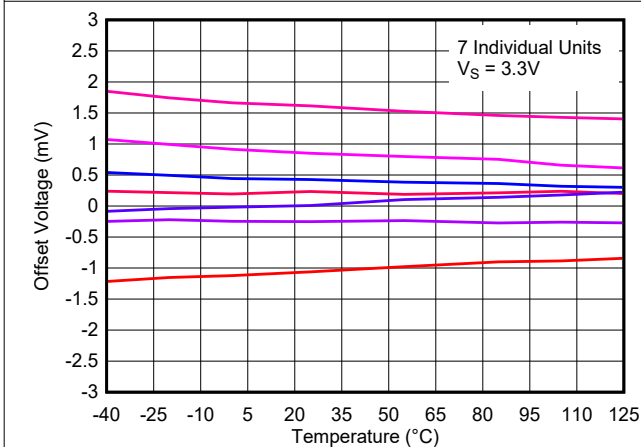

Figure 8-27. Offset Voltage vs. Temperature, 3.3 V

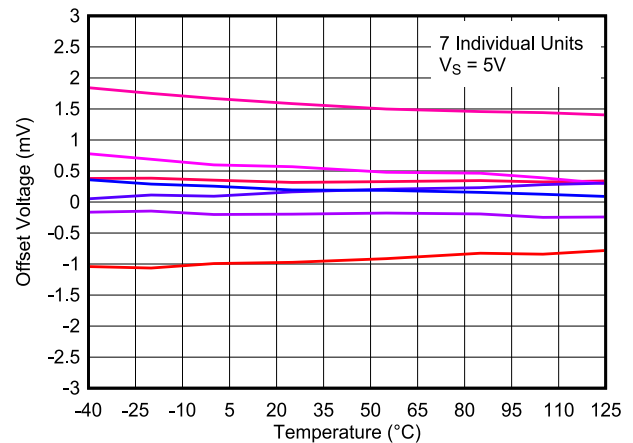

Figure 8-28. Offset Voltage vs. Temperature, 5 V

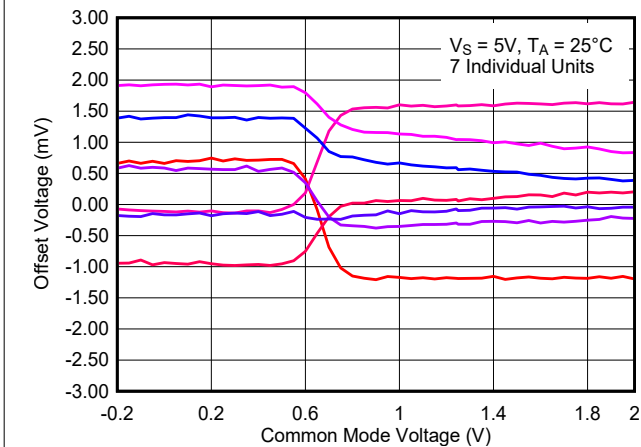

Figure 8-29. Offset Voltage vs. Common Mode Voltage, 1.8 V

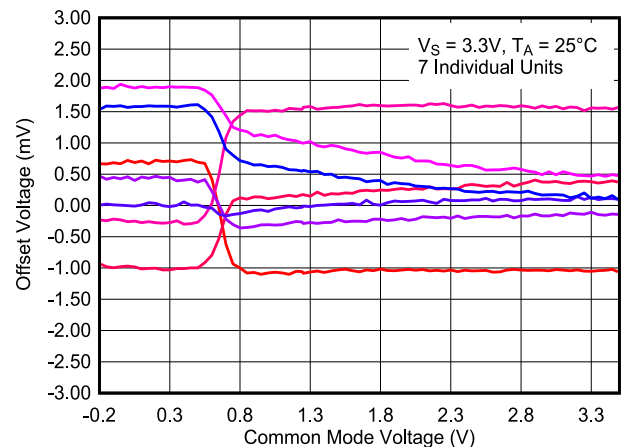

Figure 8-30. Offset Voltage vs. Common Mode Voltage, 3.3 V

8 Typical Characteristics - TLV3011B and TLV3012B (continued)

For V_S (Total Supply Voltage) = $(V+) - (V-) = +5V$, $V_{CM} = V_S / 2$ at $T_A = 25^\circ C$, $R_{PULLUP} = 1M\Omega$ to $V+$, $C_L = 15pF$, $V_{OD} = 100mV$ unless otherwise noted.

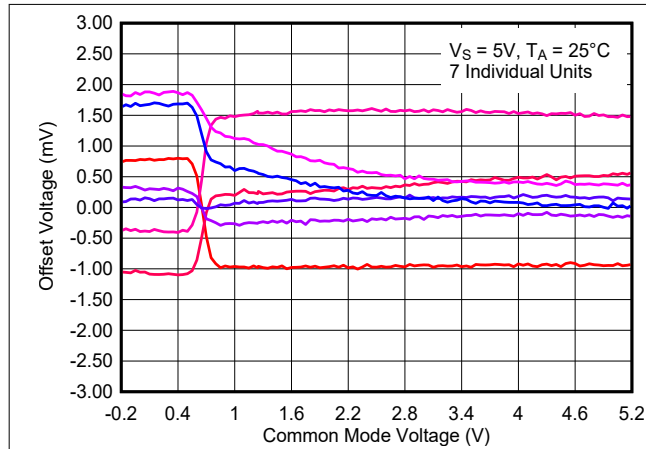

Figure 8-31. Offset Voltage vs. Common Mode Voltage, 5 V

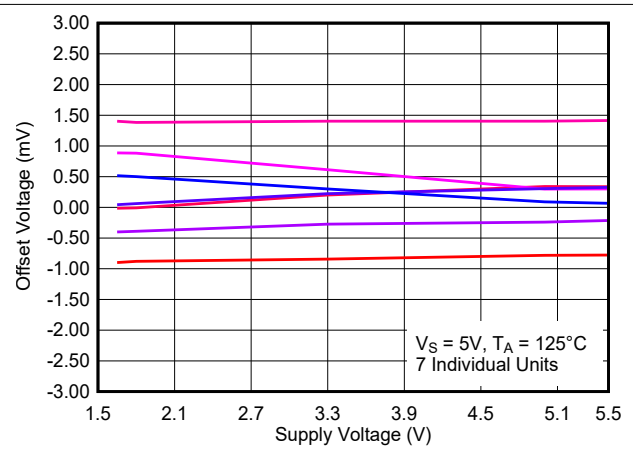

Figure 8-32. Offset Voltage vs. Supply Voltage, 125°C

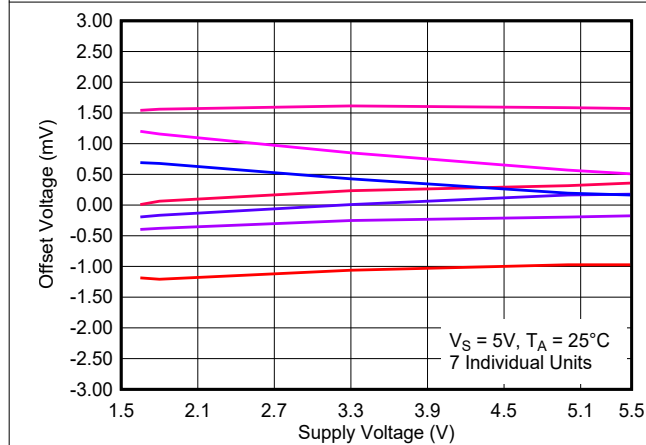

Figure 8-33. Offset Voltage vs. Supply Voltage, 25°C

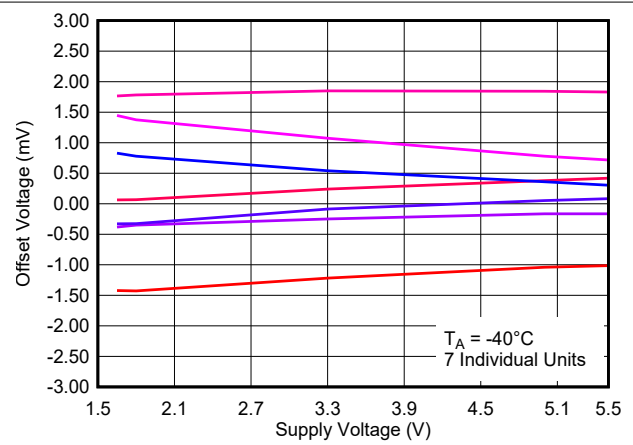

Figure 8-34. Offset Voltage vs. Supply Voltage, -40°C

9 Detailed Description

9.1 Overview

The TLV301xB is a MicroPower comparator with an integrated reference that is well suited for compact, low-current, precision voltage detection applications. With a high-accuracy, internal reference of 1.242 V and 3.1 μ A of quiescent current, the TLV301xB enables power conscious systems to monitor and respond quickly to fault conditions.

9.2 Functional Block Diagram

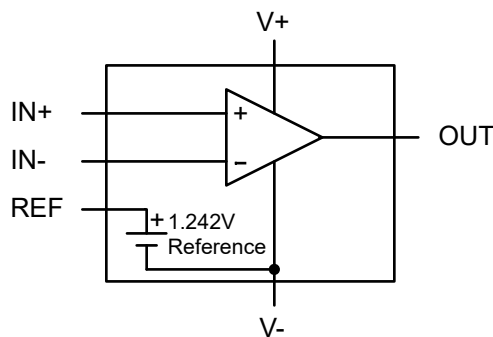

9.3 Feature Description

The TLV301x is comprised of a rail-to-rail input comparator with open-drain or push-pull output options and a voltage reference that is externally available.

9.4 Device Functional Modes

The TLV301x requires an operating voltage between 1.8 V and 5.5 V for the comparator output to reflect the voltage applied to the inputs. Similarly, the reference output (REF) will also be valid over the same operating voltage range. The "B" versions add hysteresis, power on reset, fail-safe inputs and a 1.65 V minimum supply voltage.

9.4.1 Open Drain Output (TLV3011 and TLV3011B)

The TLV3011 features an Open-Drain (sinking only) output that allows multiple devices to be driven by a single pull-up resistor to accomplish an OR function, making the TLV3011 useful for logic applications. The value of the pull-up resistor and supply voltage used will affect current consumption due to additional current drawn when the output is in a low state. This effect can be seen in the typical curve Quiescent Current vs Output Switching Frequency.

For the TLV3011, the pull-up voltage must be less than, or equal to, the V+ supply voltage ($V_{PULLUP} \leq V+$).

The TLV3011B may be pulled-up to any voltage up to 5.5V, regardless of the supply voltage.

9.4.2 Push-Pull Output (TLV3012 and TLV3012B)

The TLV3012 has a "Push-Pull" output capable of both sinking and sourcing current. The push-pull output stage is optimal for reduced power budget applications by eliminating the need for a pull-up resistor and features no shoot-through current. Do not tie push-pull outputs together.

9.4.3 Voltage Reference

The integrated 1.242-V voltage reference offers low 100-ppm/ $^{\circ}$ C (maximum) drift provided on a separate output pin that allows use of external dividers or to provide a reference voltage for other external circuitry. The reference is stable with up to a 10-nF capacitive load and can sink or source up to 500 μ A (typical) of output current.

9.4.4 TLV3011B and TLV3012B Fail-Safe inputs

The TLV3011B and TLV3012B inputs are Fail-Safe up to 5.5V independent of V+ voltage. Fail-Safe is defined as maintaining the same high input impedance when V+ is unpowered or within the recommended operating ranges.

The Fail-Safe inputs can be any value between 0 V and 5.5 V, even while V+ is zero or ramping up or down. This feature avoids power sequencing issues as long as the input voltage range and supply voltage are within the specified ranges. This is possible since the inputs are not clamped to V+ and the input current maintains its value even when a higher voltage is applied to the inputs.

As long as one of the input pins remains within the valid input range, and the supply voltage is valid and not in POR, the output state will be correct.

The following is a summary of the TLV3011B and TLV3012B device input voltage excursions and their outcomes:

1. When both IN- and IN+ are within the specified input voltage range:
 - a. If IN- is higher than IN+ and the offset voltage, the output is low.
 - b. If IN- is lower than IN+ and the offset voltage, the output is high.
2. When IN- is higher than the specified input voltage range and IN+ is within the specified voltage range, the output is low.
3. When IN+ is higher than the specified input voltage range and IN- is within the specified input voltage range, the output is high
4. When IN- and IN+ are both outside the specified input voltage range, the output state is **indeterminate** (random). *Do not* operate in this region.

Because the inputs do not have upper ESD diode clamps to V+, input voltages must be externally clamped to below 5.5 V if the source could possibly exceed 5.5 V. A current limiting resistor in series with the input is also recommend in case of input transients.

9.4.5 TLV3011B and TLV3012B Power On Reset

The TLV3011B and TLV3012B have an internal Power-on-Reset (POR) circuit for known start-up or power-down conditions. While the power supply (V+) is ramping up or ramping down, the POR circuitry will be activated for up to 1.9ms after the minimum supply voltage threshold is crossed, or immediately when the supply voltage drops below minimum supply. When the supply voltage is equal to or greater than the minimum supply voltage, and after the delay period, the comparator output reflects the state of the differential input (V_{ID}). This delay is long enough to allow the reference output to stabilize with up to a 10nF capacitive load.

During the POR period (t_{on}), the outputs will be the following:

- The open drain output TLV3011B will be high (Hi-Z).
- The push-pull output TLV3012B will be low (sinking).

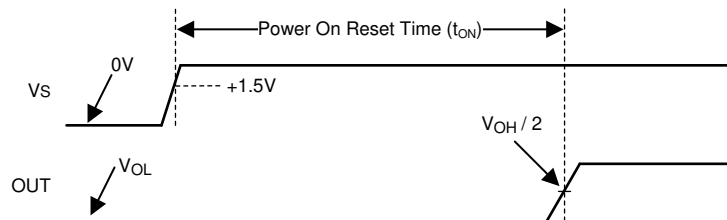

Figure 9-1. Power-On Reset Example Timing Diagram for Push-Pull Output

Note that it the nature of an open collector output that the output will rise with the pull-up voltage during the HI-Z POR period.

10 Application and Implementation

Note

Information in the following applications sections is not part of the TI component specification, and TI does not warrant its accuracy or completeness. TI's customers are responsible for determining suitability of components for their purposes, as well as validating and testing their design implementation to confirm system functionality.

10.1 Application Information

The TLV301x and TLV301xB comparator family with on-chip 1.242-V series reference with the choice of either open-drain or push-pull output stages.

A typical supply current of 2.4 μA and small packaging combine with 1.65-V supply requirements to make the TLV301xB devices optimal for battery and portable designs.

Figure 10-1 shows the typical connections for the TLV3012 device.

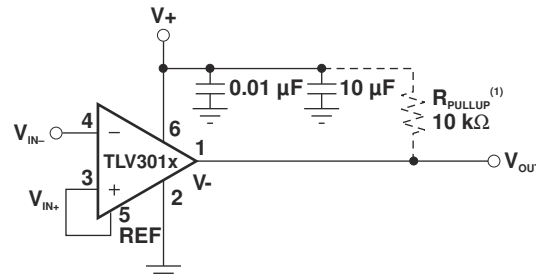

(1) Use R_{PULLUP} with the TLV3011 only.

Figure 10-1. Basic Connections

10.1.1 External Hysteresis

Comparator inputs have no noise immunity within the range of the specified offset voltage. For noisy input signals, the comparator output may display multiple switching as input signals move through the switching threshold. The typical comparator threshold of the TLV3012 device is ± 0.5 mV. To prevent multiple switching within the comparator threshold of the TLV3012 device, external hysteresis may be added by connecting a small amount of feedback to the positive input. Figure 10-2 shows a typical topology used to introduce hysteresis, described by Equation 1.

$$V_{\text{HYST}} = \frac{V_+ \times R_1}{R_1 + R_2} \quad (1)$$

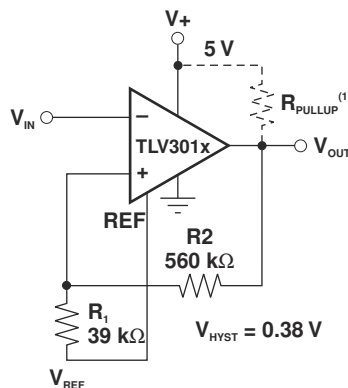

(1) Use R_{PULLUP} with the TLV3011 only.

Figure 10-2. Adding Hysteresis

The V_{HYST} voltage sets the value of the transition voltage required to switch the comparator output by increasing the threshold region, thereby reducing sensitivity to noise.

10.1.2 TLV3011B and TLV3012B Hysteresis

The TLV3011B and TLV3012B have typically 6mV of built-in hysteresis. External hysteresis can still be added as explained in the previous section.

10.2 Typical Application

10.2.1 Under-Voltage Detection

Under-voltage detection is frequently required to alert the system that a battery voltage has dropped below the usable voltage level. Figure 23 shows a simple under-voltage detection circuit using the TLV3012 which is configured as a non-inverting comparator with the integrated 1.242 V reference is externally connected to the inverting input pin (IN-).

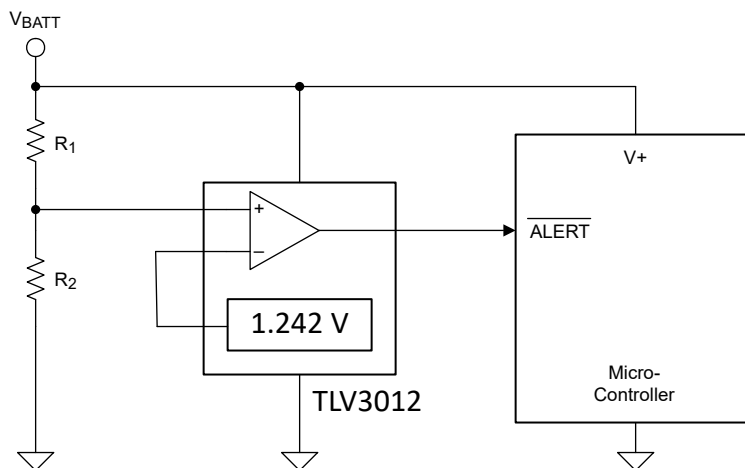

Figure 10-3. Under-Voltage Detection

10.2.1.1 Design Requirements

For this design, follow these design requirements:

- Operate from power supply that powers the microcontroller.
- Under-voltage alert is active low.
- Logic low output when V_{BAT} is less than 2.0V.

10.2.1.2 Detailed Design Procedure

Configure the circuit as shown in Figure 10-3. Connect (V+) to V_{BAT} which also powers the microcontroller. Resistors R_1 and R_2 create the under-voltage alert level of 2.0 V. When the battery voltage sags down to 2.0 V, the resistor divider voltage crosses V_{REF} , the 1.242 V reference threshold of the TLV3012. This causes the comparator output to transition from a logic high to a logic low. The push-pull output of the TLV3012 is selected since the comparator operating voltage is shared with the microcontroller which is receiving the under-voltage alert signal.

Equation 2 is derived from the analysis of Figure 10-3.

$$V_{REF} = \frac{R_2}{R_1 + R_2} \times V_{BAT} \quad (2)$$

where

- R_1 and R_2 are the resistor values for the resistor divider connected to IN+
- V_{BAT} is the voltage source that is being monitored for an undervoltage condition.
- V_{REF} is the falling edge threshold where the comparator output changes state from high to low

Rearranging [Equation 2](#) and solving for R_1 yields [Equation 3](#).

$$R_1 = \frac{(V_{BAT} - V_{REF})}{V_{REF}} \times R_2 \quad (3)$$

For the specific undervoltage detection of 2.0 V using the TLV3012, the following results are calculated.

$$R_1 = \frac{(2.0 - 1.242)}{1.242} \times 1M = 610 \text{ k}\Omega \quad (4)$$

where

- R_2 is set to 1 M Ω
- V_{BAT} is set to 2.0 V
- V_{REF} is set to 1.242 V

Choose R_{TOTAL} ($R_1 + R_2$) such that the current through the divider is at least 100 times higher than the input bias current (I_{BIAS}). The resistors can have high values to minimize current consumption in the circuit without adding significant error to the resistive divider.

10.2.1.3 Application Curve

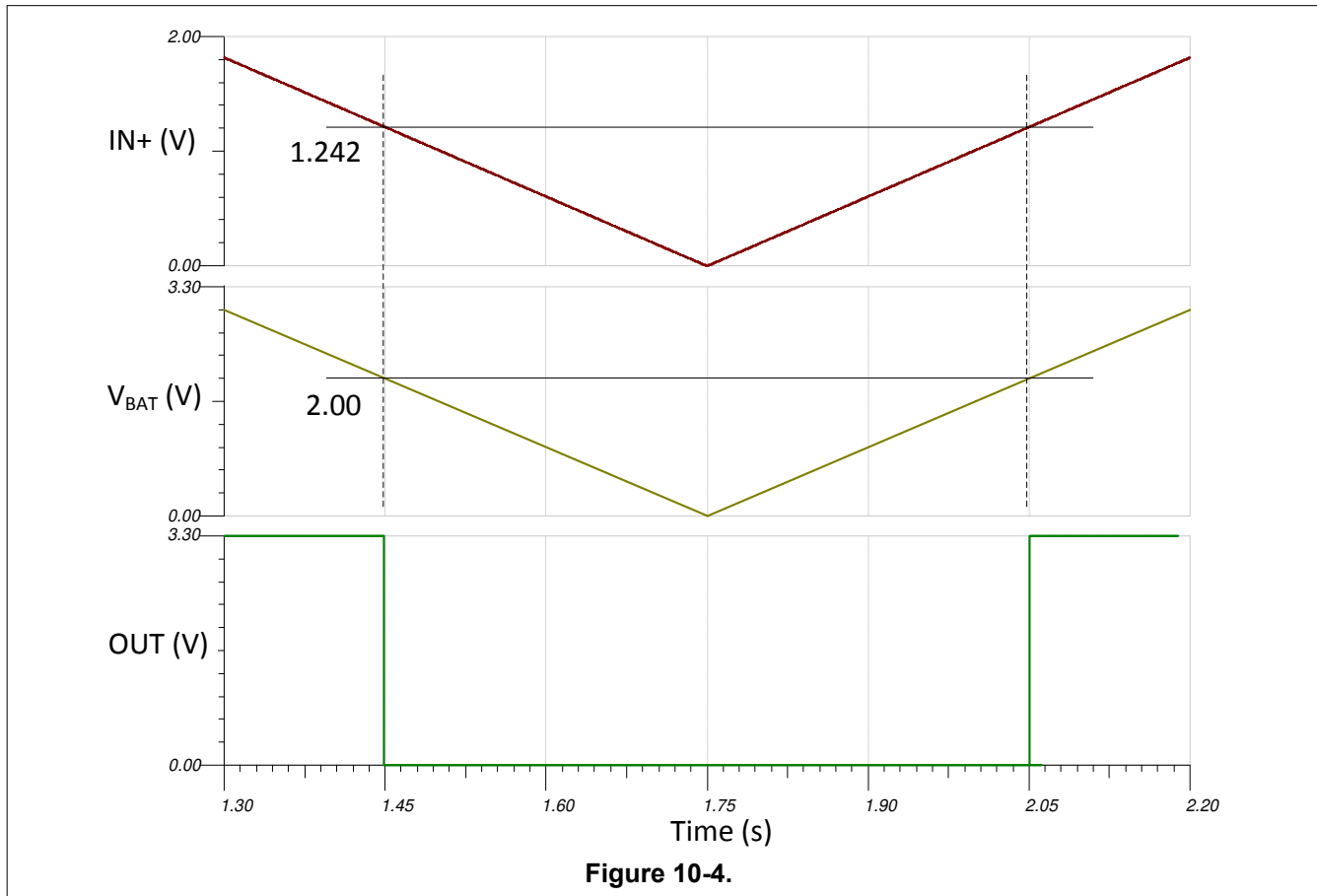

10.3 System Examples

10.3.1 Power-On Reset

The reset circuit shown in [Figure 10-5](#) provides a time-delayed release of reset to the [MSP430™](#) microcontroller. Operation of the circuit is based on a stabilization time constant of the supply voltage, rather than on a predetermined voltage value. The negative input is a reference voltage created by the internal voltage reference. The positive input is an RC circuit that provides a power-up delay. When power is applied, the output of the comparator is low, holding the processor in the reset condition. Only after allowing time for the supply voltage to stabilize does the positive input of the comparator become higher than the negative input, resulting in a high output state, releasing the processor for operation. The stabilization time required for the supply voltage is adjustable by the selection of the RC component values. Use of a lower-valued resistor in this portion of the circuit does not increase current consumption, because no current flows through the RC circuit after the supply has stabilized.

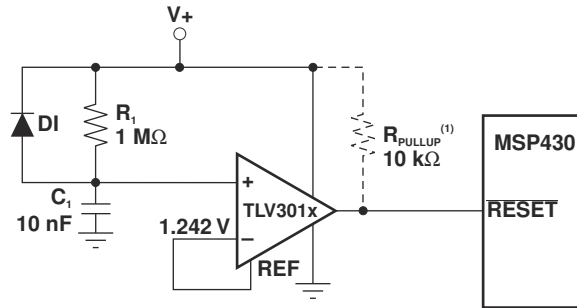

(1) Use R_{PULLUP} with the TLV3011 only.

Figure 10-5. TLV3012 Configured as Power-Up Reset Circuit for the MSP430™ Microcontroller

The reset delay needed depends on the power-up characteristics of the system power supply. R_1 and C_1 are selected to allow enough time for the power supply to stabilize. D_1 provides rapid reset if power is lost. In this example, the $R_1 \times C_1$ time constant is 10 ms.

10.3.2 Relaxation Oscillator

The TLV3012 device can be configured as a relaxation oscillator to provide a simple and inexpensive clock output (see Figure 10-6). The capacitor is charged at a rate of $T = 0.69RC$ and discharges at a rate of $0.69RC$. Therefore, the period is $T = 1.38RC$. R_1 may be a different value than R_2 .

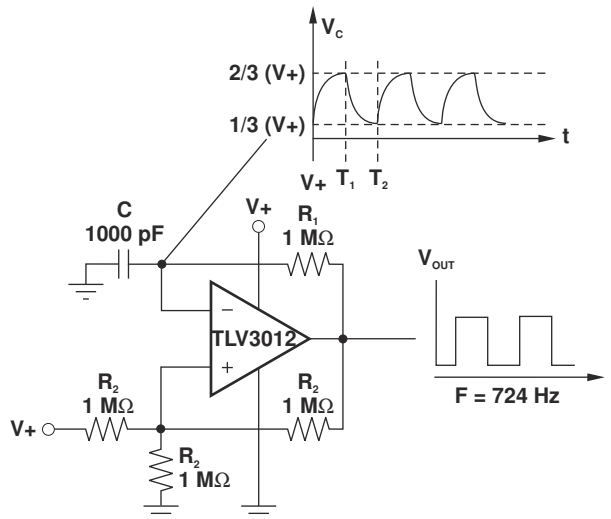

Figure 10-6. TLV3012 Configured as Relaxation Oscillator

10.4 Power Supply Recommendations

The TLV3012 has a recommended operating voltage range (V_S) of 1.8 V to 5.5 V. V_S is defined as $(V+) - (V-)$. Therefore, the supply voltages used to create V_S can be single-ended or bipolar. For example, single-ended supply voltages of 5 V and 0 V and bipolar supply voltages of +2.5 V and -2.5 V create comparable operating voltages for V_S . However, when bipolar supply voltages are used, it is important to realize that the reference (REF) and logic low level of the comparator output is referenced to $(V-)$. Output capacitive loading and output toggle rate will cause the average supply current to rise over the quiescent current in the EC Table.

10.5 Layout

10.5.1 Layout Guidelines

To minimize supply noise, power supplies should be capacitively decoupled by a 0.1- μ F ceramic capacitor. Comparators are sensitive to input noise and precautions such as proper grounding (use of ground plane),

supply bypassing, and guarding of high-impedance nodes minimize the effects of noise and help to ensure specified performance.

10.5.2 Layout Example

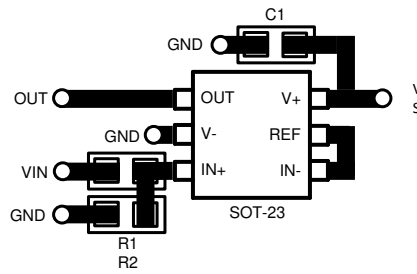

Figure 10-7. Layout Example

11 Device and Documentation Support

11.1 Receiving Notification of Documentation Updates

To receive notification of documentation updates, navigate to the device product folder on ti.com. Click on *Subscribe to updates* to register and receive a weekly digest of any product information that has changed. For change details, review the revision history included in any revised document.

11.2 Support Resources

[TI E2E™ support forums](#) are an engineer's go-to source for fast, verified answers and design help — straight from the experts. Search existing answers or ask your own question to get the quick design help you need.

Linked content is provided "AS IS" by the respective contributors. They do not constitute TI specifications and do not necessarily reflect TI's views; see TI's [Terms of Use](#).

11.3 Trademarks

MSP430™ is a trademark of Texas Instruments.

TI E2E™ is a trademark of Texas Instruments.

All trademarks are the property of their respective owners.

11.4 Electrostatic Discharge Caution



This integrated circuit can be damaged by ESD. Texas Instruments recommends that all integrated circuits be handled with appropriate precautions. Failure to observe proper handling and installation procedures can cause damage.

ESD damage can range from subtle performance degradation to complete device failure. Precision integrated circuits may be more susceptible to damage because very small parametric changes could cause the device not to meet its published specifications.

11.5 Glossary

[TI Glossary](#) This glossary lists and explains terms, acronyms, and definitions.

12 Mechanical, Packaging, and Orderable Information

The following pages include mechanical, packaging, and orderable information. This information is the most current data available for the designated devices. This data is subject to change without notice and revision of this document. For browser-based versions of this data sheet, refer to the left-hand navigation.

PACKAGING INFORMATION

| Orderable Device | Status (1) | Package Type | Package Drawing | Pins | Package Qty | Eco Plan (2) | Lead finish/ Ball material (6) | MSL Peak Temp (3) | Op Temp (°C) | Device Marking (4/5) | Samples |
|------------------|---------------|--------------|-----------------|------|-------------|-----------------|--------------------------------------|----------------------|--------------|-------------------------|-------------------------|
| TLV3011AIDBVR | ACTIVE | SOT-23 | DBV | 6 | 3000 | RoHS & Green | NIPDAU | Level-2-260C-1 YEAR | -40 to 125 | ALR | Samples |
| TLV3011AIDBVT | ACTIVE | SOT-23 | DBV | 6 | 250 | RoHS & Green | NIPDAU | Level-2-260C-1 YEAR | -40 to 125 | ALR | Samples |
| TLV3011AIDBVTG4 | ACTIVE | SOT-23 | DBV | 6 | 250 | RoHS & Green | NIPDAU | Level-2-260C-1 YEAR | -40 to 125 | ALR | Samples |
| TLV3011AIDCKR | ACTIVE | SC70 | DCK | 6 | 3000 | RoHS & Green | NIPDAU SN | Level-1-260C-UNLIM | -40 to 125 | AJX | Samples |
| TLV3011AIDCKRG4 | LIFEBUY | SC70 | DCK | 6 | 3000 | RoHS & Green | NIPDAU | Level-1-260C-UNLIM | -40 to 125 | AJX | |
| TLV3011AIDCKT | ACTIVE | SC70 | DCK | 6 | 250 | RoHS & Green | NIPDAU SN | Level-1-260C-UNLIM | -40 to 125 | AJX | Samples |
| TLV3011AIDCKTG4 | LIFEBUY | SC70 | DCK | 6 | 250 | RoHS & Green | NIPDAU | Level-1-260C-UNLIM | -40 to 125 | AJX | |
| TLV3011BIDBVR | ACTIVE | SOT-23 | DBV | 6 | 3000 | RoHS & Green | NIPDAU | Level-1-260C-UNLIM | -40 to 125 | 31KF | Samples |
| TLV3011BIDCKR | ACTIVE | SC70 | DCK | 6 | 3000 | RoHS & Green | SN | Level-1-260C-UNLIM | -40 to 125 | 1O8 | Samples |
| TLV3012AIDBVR | ACTIVE | SOT-23 | DBV | 6 | 3000 | RoHS & Green | NIPDAU | Level-2-260C-1 YEAR | -40 to 125 | ALS | Samples |
| TLV3012AIDBVRG4 | ACTIVE | SOT-23 | DBV | 6 | 3000 | RoHS & Green | NIPDAU | Level-2-260C-1 YEAR | -40 to 125 | ALS | Samples |
| TLV3012AIDBVT | ACTIVE | SOT-23 | DBV | 6 | 250 | RoHS & Green | NIPDAU | Level-2-260C-1 YEAR | -40 to 125 | ALS | Samples |
| TLV3012AIDBVTG4 | ACTIVE | SOT-23 | DBV | 6 | 250 | RoHS & Green | NIPDAU | Level-2-260C-1 YEAR | -40 to 125 | ALS | Samples |
| TLV3012AIDCKR | ACTIVE | SC70 | DCK | 6 | 3000 | RoHS & Green | NIPDAU SN | Level-1-260C-UNLIM | -40 to 125 | ALT | Samples |
| TLV3012AIDCKRG4 | LIFEBUY | SC70 | DCK | 6 | 3000 | RoHS & Green | NIPDAU | Level-1-260C-UNLIM | -40 to 125 | ALT | |
| TLV3012AIDCKT | ACTIVE | SC70 | DCK | 6 | 250 | RoHS & Green | NIPDAU SN | Level-1-260C-UNLIM | -40 to 125 | ALT | Samples |
| TLV3012BIDBVR | ACTIVE | SOT-23 | DBV | 6 | 3000 | RoHS & Green | NIPDAU | Level-1-260C-UNLIM | -40 to 125 | 31LF | Samples |
| TLV3012BIDCKR | ACTIVE | SC70 | DCK | 6 | 3000 | RoHS & Green | SN | Level-1-260C-UNLIM | -40 to 125 | 1O9 | Samples |

⁽¹⁾ The marketing status values are defined as follows:

ACTIVE: Product device recommended for new designs.

LIFEBUY: TI has announced that the device will be discontinued, and a lifetime-buy period is in effect.

NRND: Not recommended for new designs. Device is in production to support existing customers, but TI does not recommend using this part in a new design.

PREVIEW: Device has been announced but is not in production. Samples may or may not be available.

OBSOLETE: TI has discontinued the production of the device.

(2) RoHS: TI defines "RoHS" to mean semiconductor products that are compliant with the current EU RoHS requirements for all 10 RoHS substances, including the requirement that RoHS substance do not exceed 0.1% by weight in homogeneous materials. Where designed to be soldered at high temperatures, "RoHS" products are suitable for use in specified lead-free processes. TI may reference these types of products as "Pb-Free".

RoHS Exempt: TI defines "RoHS Exempt" to mean products that contain lead but are compliant with EU RoHS pursuant to a specific EU RoHS exemption.

Green: TI defines "Green" to mean the content of Chlorine (Cl) and Bromine (Br) based flame retardants meet JS709B low halogen requirements of ≤ 1000 ppm threshold. Antimony trioxide based flame retardants must also meet the ≤ 1000 ppm threshold requirement.

(3) MSL, Peak Temp. - The Moisture Sensitivity Level rating according to the JEDEC industry standard classifications, and peak solder temperature.

(4) There may be additional marking, which relates to the logo, the lot trace code information, or the environmental category on the device.

(5) Multiple Device Markings will be inside parentheses. Only one Device Marking contained in parentheses and separated by a "~" will appear on a device. If a line is indented then it is a continuation of the previous line and the two combined represent the entire Device Marking for that device.

(6) Lead finish/Ball material - Orderable Devices may have multiple material finish options. Finish options are separated by a vertical ruled line. Lead finish/Ball material values may wrap to two lines if the finish value exceeds the maximum column width.

Important Information and Disclaimer:The information provided on this page represents TI's knowledge and belief as of the date that it is provided. TI bases its knowledge and belief on information provided by third parties, and makes no representation or warranty as to the accuracy of such information. Efforts are underway to better integrate information from third parties. TI has taken and continues to take reasonable steps to provide representative and accurate information but may not have conducted destructive testing or chemical analysis on incoming materials and chemicals. TI and TI suppliers consider certain information to be proprietary, and thus CAS numbers and other limited information may not be available for release.

In no event shall TI's liability arising out of such information exceed the total purchase price of the TI part(s) at issue in this document sold by TI to Customer on an annual basis.

OTHER QUALIFIED VERSIONS OF TLV3011, TLV3011B, TLV3012, TLV3012B :

● Automotive : [TLV3011-Q1](#), [TLV3011B-Q1](#), [TLV3012-Q1](#), [TLV3012B-Q1](#)

● Enhanced Product : [TLV3011-EP](#), [TLV3012-EP](#)

NOTE: Qualified Version Definitions:

- Automotive - Q100 devices qualified for high-reliability automotive applications targeting zero defects
- Enhanced Product - Supports Defense, Aerospace and Medical Applications

TAPE AND REEL INFORMATION

QUADRANT ASSIGNMENTS FOR PIN 1 ORIENTATION IN TAPE

*All dimensions are nominal

| Device | Package Type | Package Drawing | Pins | SPQ | Reel Diameter (mm) | Reel Width W1 (mm) | A0 (mm) | B0 (mm) | K0 (mm) | P1 (mm) | W (mm) | Pin1 Quadrant |
|-----------------|--------------|-----------------|------|------|--------------------|--------------------|---------|---------|---------|---------|--------|---------------|
| TLV3011AIDBVR | SOT-23 | DBV | 6 | 3000 | 180.0 | 8.4 | 3.2 | 3.2 | 1.4 | 4.0 | 8.0 | Q3 |
| TLV3011AIDBVT | SOT-23 | DBV | 6 | 250 | 178.0 | 9.0 | 3.23 | 3.17 | 1.37 | 4.0 | 8.0 | Q3 |
| TLV3011AIDCKR | SC70 | DCK | 6 | 3000 | 178.0 | 9.0 | 2.4 | 2.5 | 1.2 | 4.0 | 8.0 | Q3 |
| TLV3011AIDCKRG4 | SC70 | DCK | 6 | 3000 | 178.0 | 9.0 | 2.4 | 2.5 | 1.2 | 4.0 | 8.0 | Q3 |
| TLV3011AIDCKRG4 | SC70 | DCK | 6 | 3000 | 179.0 | 8.4 | 2.2 | 2.5 | 1.2 | 4.0 | 8.0 | Q3 |
| TLV3011AIDCKT | SC70 | DCK | 6 | 250 | 178.0 | 9.0 | 2.4 | 2.5 | 1.2 | 4.0 | 8.0 | Q3 |
| TLV3011AIDCKTG4 | SC70 | DCK | 6 | 250 | 178.0 | 9.0 | 2.4 | 2.5 | 1.2 | 4.0 | 8.0 | Q3 |
| TLV3011BIDBVR | SOT-23 | DBV | 6 | 3000 | 180.0 | 8.4 | 3.2 | 3.2 | 1.4 | 4.0 | 8.0 | Q3 |
| TLV3011BIDCKR | SC70 | DCK | 6 | 3000 | 178.0 | 9.0 | 2.4 | 2.5 | 1.2 | 4.0 | 8.0 | Q3 |
| TLV3012AIDBVR | SOT-23 | DBV | 6 | 3000 | 180.0 | 8.4 | 3.2 | 3.2 | 1.4 | 4.0 | 8.0 | Q3 |
| TLV3012AIDCKR | SC70 | DCK | 6 | 3000 | 178.0 | 9.0 | 2.4 | 2.5 | 1.2 | 4.0 | 8.0 | Q3 |
| TLV3012AIDCKR | SC70 | DCK | 6 | 3000 | 178.0 | 9.0 | 2.4 | 2.5 | 1.2 | 4.0 | 8.0 | Q3 |
| TLV3012AIDCKRG4 | SC70 | DCK | 6 | 3000 | 178.0 | 9.0 | 2.4 | 2.5 | 1.2 | 4.0 | 8.0 | Q3 |
| TLV3012AIDCKT | SC70 | DCK | 6 | 250 | 178.0 | 9.0 | 2.4 | 2.5 | 1.2 | 4.0 | 8.0 | Q3 |
| TLV3012BIDBVR | SOT-23 | DBV | 6 | 3000 | 180.0 | 8.4 | 3.2 | 3.2 | 1.4 | 4.0 | 8.0 | Q3 |
| TLV3012BIDCKR | SC70 | DCK | 6 | 3000 | 178.0 | 9.0 | 2.4 | 2.5 | 1.2 | 4.0 | 8.0 | Q3 |

TAPE AND REEL BOX DIMENSIONS

*All dimensions are nominal

| Device | Package Type | Package Drawing | Pins | SPQ | Length (mm) | Width (mm) | Height (mm) |
|-----------------|--------------|-----------------|------|------|-------------|------------|-------------|
| TLV3011AIDBVR | SOT-23 | DBV | 6 | 3000 | 210.0 | 185.0 | 35.0 |
| TLV3011AIDBVT | SOT-23 | DBV | 6 | 250 | 180.0 | 180.0 | 18.0 |
| TLV3011AIDCKR | SC70 | DCK | 6 | 3000 | 180.0 | 180.0 | 18.0 |
| TLV3011AIDCKRG4 | SC70 | DCK | 6 | 3000 | 180.0 | 180.0 | 18.0 |
| TLV3011AIDCKRG4 | SC70 | DCK | 6 | 3000 | 203.0 | 203.0 | 35.0 |
| TLV3011AIDCKT | SC70 | DCK | 6 | 250 | 180.0 | 180.0 | 18.0 |
| TLV3011AIDCKTG4 | SC70 | DCK | 6 | 250 | 180.0 | 180.0 | 18.0 |
| TLV3011BIDBVR | SOT-23 | DBV | 6 | 3000 | 210.0 | 185.0 | 35.0 |
| TLV3011BIDCKR | SC70 | DCK | 6 | 3000 | 180.0 | 180.0 | 18.0 |
| TLV3012AIDBVR | SOT-23 | DBV | 6 | 3000 | 210.0 | 185.0 | 35.0 |
| TLV3012AIDCKR | SC70 | DCK | 6 | 3000 | 180.0 | 180.0 | 18.0 |
| TLV3012AIDCKR | SC70 | DCK | 6 | 3000 | 180.0 | 180.0 | 18.0 |
| TLV3012AIDCKRG4 | SC70 | DCK | 6 | 3000 | 180.0 | 180.0 | 18.0 |
| TLV3012AIDCKT | SC70 | DCK | 6 | 250 | 180.0 | 180.0 | 18.0 |
| TLV3012BIDBVR | SOT-23 | DBV | 6 | 3000 | 210.0 | 185.0 | 35.0 |
| TLV3012BIDCKR | SC70 | DCK | 6 | 3000 | 180.0 | 180.0 | 18.0 |

DBV0006A



PACKAGE OUTLINE

SOT-23 - 1.45 mm max height

SMALL OUTLINE TRANSISTOR



4214840/G 08/2024

NOTES:

1. All linear dimensions are in millimeters. Any dimensions in parenthesis are for reference only. Dimensioning and tolerancing per ASME Y14.5M.
2. This drawing is subject to change without notice.
3. Body dimensions do not include mold flash or protrusion. Mold flash and protrusion shall not exceed 0.25 per side.
4. Leads 1,2,3 may be wider than leads 4,5,6 for package orientation.
5. Reference JEDEC MO-178.

EXAMPLE BOARD LAYOUT

DBV0006A

SOT-23 - 1.45 mm max height

SMALL OUTLINE TRANSISTOR



LAND PATTERN EXAMPLE
EXPOSED METAL SHOWN
SCALE:15X

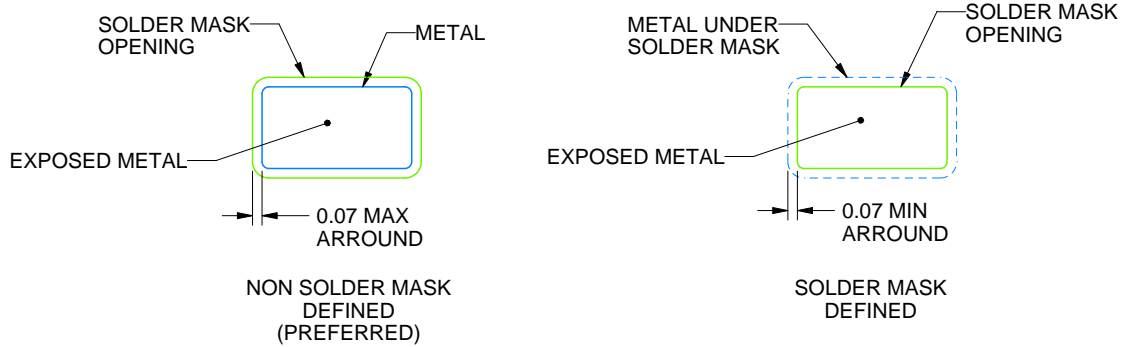

SOLDER MASK DETAILS

4214840/G 08/2024

NOTES: (continued)

6. Publication IPC-7351 may have alternate designs.
7. Solder mask tolerances between and around signal pads can vary based on board fabrication site.

EXAMPLE STENCIL DESIGN

DBV0006A

SOT-23 - 1.45 mm max height

SMALL OUTLINE TRANSISTOR



SOLDER PASTE EXAMPLE
BASED ON 0.125 mm THICK STENCIL
SCALE:15X

4214840/G 08/2024

NOTES: (continued)

8. Laser cutting apertures with trapezoidal walls and rounded corners may offer better paste release. IPC-7525 may have alternate design recommendations.
9. Board assembly site may have different recommendations for stencil design.

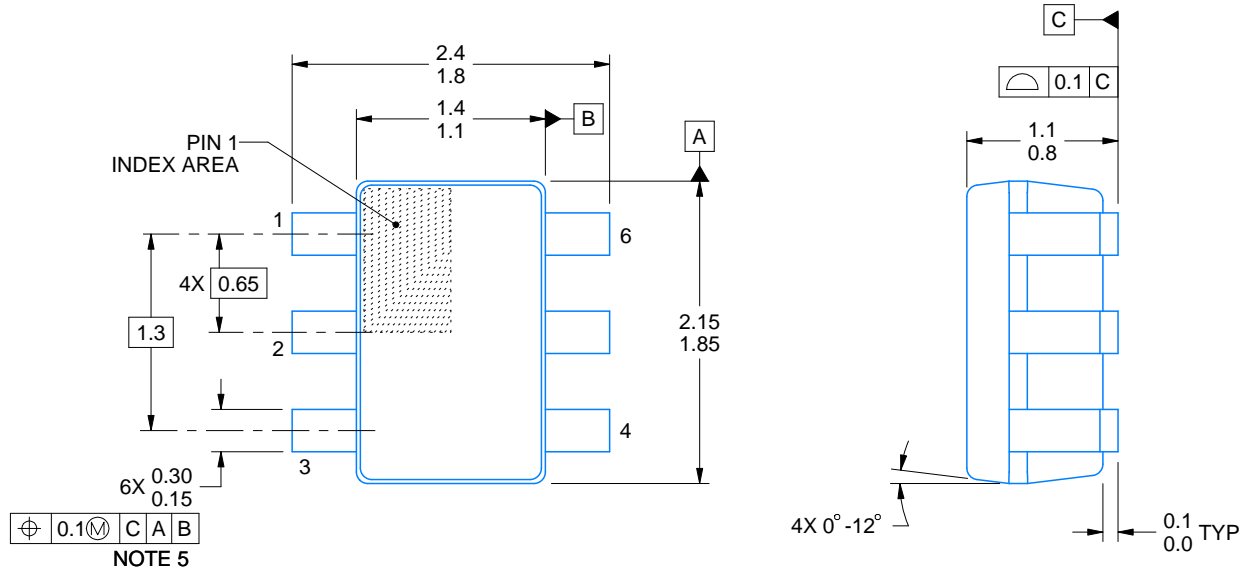

4214835/C 08/2024

NOTES:

1. All linear dimensions are in millimeters. Any dimensions in parenthesis are for reference only. Dimensioning and tolerancing per ASME Y14.5M.
2. This drawing is subject to change without notice.
3. Body dimensions do not include mold flash or protrusion. Mold flash and protrusion shall not exceed 0.15 per side.
4. Falls within JEDEC MO-203 variation AB.



LAND PATTERN EXAMPLE
EXPOSED METAL SHOWN
SCALE:18X

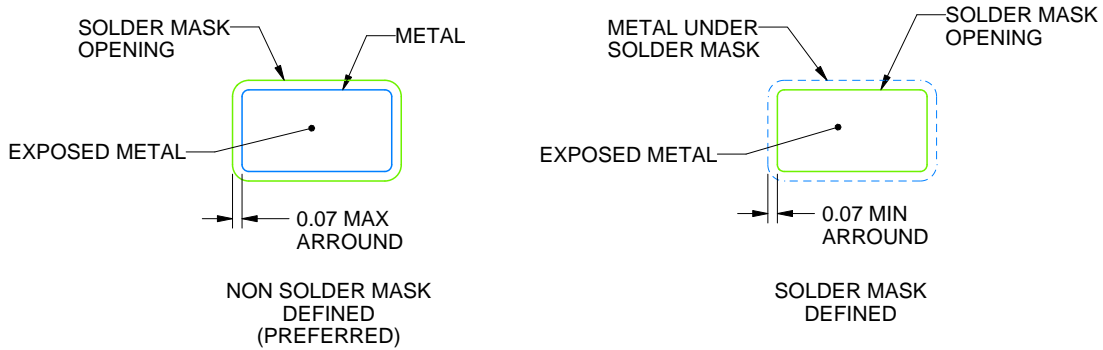

SOLDER MASK DETAILS

4214835/C 08/2024

NOTES: (continued)

- 5. Publication IPC-7351 may have alternate designs.
- 6. Solder mask tolerances between and around signal pads can vary based on board fabrication site.



SOLDER PASTE EXAMPLE
BASED ON 0.125 THICK STENCIL
SCALE:18X

4214835/C 08/2024

NOTES: (continued)

7. Laser cutting apertures with trapezoidal walls and rounded corners may offer better paste release. IPC-7525 may have alternate design recommendations.
8. Board assembly site may have different recommendations for stencil design.

IMPORTANT NOTICE AND DISCLAIMER

TI PROVIDES TECHNICAL AND RELIABILITY DATA (INCLUDING DATA SHEETS), DESIGN RESOURCES (INCLUDING REFERENCE DESIGNS), APPLICATION OR OTHER DESIGN ADVICE, WEB TOOLS, SAFETY INFORMATION, AND OTHER RESOURCES "AS IS" AND WITH ALL FAULTS, AND DISCLAIMS ALL WARRANTIES, EXPRESS AND IMPLIED, INCLUDING WITHOUT LIMITATION ANY IMPLIED WARRANTIES OF MERCHANTABILITY, FITNESS FOR A PARTICULAR PURPOSE OR NON-INFRINGEMENT OF THIRD PARTY INTELLECTUAL PROPERTY RIGHTS.

These resources are intended for skilled developers designing with TI products. You are solely responsible for (1) selecting the appropriate TI products for your application, (2) designing, validating and testing your application, and (3) ensuring your application meets applicable standards, and any other safety, security, regulatory or other requirements.

These resources are subject to change without notice. TI grants you permission to use these resources only for development of an application that uses the TI products described in the resource. Other reproduction and display of these resources is prohibited. No license is granted to any other TI intellectual property right or to any third party intellectual property right. TI disclaims responsibility for, and you will fully indemnify TI and its representatives against, any claims, damages, costs, losses, and liabilities arising out of your use of these resources.

TI's products are provided subject to [TI's Terms of Sale](#) or other applicable terms available either on [ti.com](https://www.ti.com) or provided in conjunction with such TI products. TI's provision of these resources does not expand or otherwise alter TI's applicable warranties or warranty disclaimers for TI products.

TI objects to and rejects any additional or different terms you may have proposed.

Mailing Address: Texas Instruments, Post Office Box 655303, Dallas, Texas 75265
Copyright © 2024, Texas Instruments Incorporated