

# High Current Power MOSFET

**IXTH 50N30**  
**IXTT 50N30**

$V_{DSS} = 300 \text{ V}$   
 $I_{D25} = 50 \text{ A}$   
 $R_{DS(on)} = 65 \text{ m}\Omega$

N-Channel Enhancement Mode

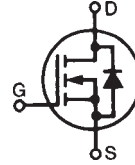

Symbol	Test Conditions	Maximum Ratings	
$V_{DSS}$	$T_J = 25^\circ\text{C}$ to $150^\circ\text{C}$	300	V
$V_{DGR}$	$T_J = 25^\circ\text{C}$ to $150^\circ\text{C}$ ; $R_{GS} = 1 \text{ M}\Omega$	300	V
$V_{GS}$	Continuous	$\pm 20$	V
$V_{GSM}$	Transient	$\pm 30$	V
$I_{D25}$	$T_C = 25^\circ\text{C}$	50	A
$I_{DM}$	$T_C = 25^\circ\text{C}$ , pulse width limited by $T_{JM}$	200	A
$I_{AR}$	$T_C = 25^\circ\text{C}$	50	A
$E_{AR}$	$T_C = 25^\circ\text{C}$	50	mJ
$E_{AS}$	$T_C = 25^\circ\text{C}$	1.5	J
$dv/dt$	$I_S \leq I_{DM}$ , $di/dt \leq 100 \text{ A}/\mu\text{s}$ , $V_{DD} \leq V_{DSS}$ , $T_J \leq 150^\circ\text{C}$ , $R_G = 2 \Omega$	5	V/ns
$P_D$	$T_C = 25^\circ\text{C}$	400	W
$T_J$		-55 ... +150	$^\circ\text{C}$
$T_{JM}$		150	$^\circ\text{C}$
$T_{stg}$		-55 ... +150	$^\circ\text{C}$
$T_L$	1.6 mm (0.062 in.) from case for 10 s	300	$^\circ\text{C}$
$M_d$	Mounting torque (TO-247)	1.13/10	Nm/lb.in.
Weight	TO-247	6	g
	TO-268	5	g

TO-247 (IXTH)

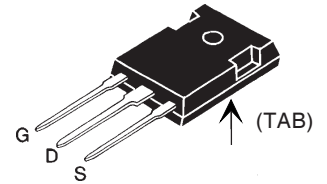

TO-268 (IXTT)

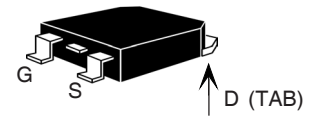

G = Gate      D = Drain  
S = Source      TAB = Drain

## Features

- International standard packages
- Low  $R_{DS(on)}$  HDMOS™ process
- Rugged polysilicon gate cell structure
- Unclamped Inductive Switching (UIS) rated
- Low package inductance  
- easy to drive and to protect

## Advantages

- Easy to mount
- Space savings
- High power density

Symbol	Test Conditions ( $T_J = 25^\circ\text{C}$ , unless otherwise specified)	Characteristic Values		
		Min.	Typ.	Max.
$V_{DSS}$	$V_{GS} = 0 \text{ V}$ , $I_D = 250 \mu\text{A}$	300		V
$V_{GS(th)}$	$V_{DS} = V_{GS}$ , $I_D = 250 \mu\text{A}$	2.0		V
$I_{GSS}$	$V_{GS} = \pm 20 \text{ V}_{DC}$ , $V_{DS} = 0$			$\pm 100 \text{ nA}$
$I_{DSS}$	$V_{DS} = V_{DSS}$ $V_{GS} = 0 \text{ V}$	$T_J = 25^\circ\text{C}$		25 $\mu\text{A}$
		$T_J = 125^\circ\text{C}$		250 $\mu\text{A}$
$R_{DS(on)}$	$V_{GS} = 10 \text{ V}$ , $I_D = 0.5 I_{D25}$ Pulse test, $t \leq 300 \mu\text{s}$ , duty cycle $d \leq 2\%$			65 $\text{m}\Omega$

Symbol	Test Conditions	Characteristic Values		
		(T <sub>J</sub> = 25°C, unless otherwise specified)		
		Min.	Typ.	Max.
<b>g<sub>fs</sub></b>	V <sub>DS</sub> = 10 V; I <sub>D</sub> = 0.5 I <sub>D25</sub> , pulse test	24	36	S
<b>C<sub>iss</sub></b>	V <sub>GS</sub> = 0 V, V <sub>DS</sub> = 25 V, f = 1 MHz		4400	pF
<b>C<sub>oss</sub></b>			700	pF
<b>C<sub>rss</sub></b>			240	pF
<b>t<sub>d(on)</sub></b>	V <sub>GS</sub> = 10 V, V <sub>DS</sub> = 0.5 V <sub>DSS</sub> , I <sub>D</sub> = 0.5 I <sub>D25</sub> R <sub>G</sub> = 2 Ω (External)		24	ns
<b>t<sub>r</sub></b>			33	ns
<b>t<sub>d(off)</sub></b>			70	ns
<b>t<sub>f</sub></b>			17	ns
<b>Q<sub>g(on)</sub></b>	V <sub>GS</sub> = 10 V, V <sub>DS</sub> = 0.5 V <sub>DSS</sub> , I <sub>D</sub> = 0.5 I <sub>D25</sub>		165	nC
<b>Q<sub>gs</sub></b>			30	nC
<b>Q<sub>gd</sub></b>			80	nC
<b>R<sub>thJC</sub></b>	(TO-247)		0.21	0.31 K/W
<b>R<sub>thCK</sub></b>				K/W

Symbol	Test Conditions	Characteristic Values		
		(T <sub>J</sub> = 25°C, unless otherwise specified)		
		min.	typ.	max.
<b>I<sub>S</sub></b>	V <sub>GS</sub> = 0 V			50 A
<b>I<sub>SM</sub></b>	Repetitive			200 A
<b>V<sub>SD</sub></b>	I <sub>F</sub> = I <sub>S</sub> , V <sub>GS</sub> = 0 V, Pulse test, t ≤ 300 μs, duty cycle d ≤ 2 %			1.5 V
<b>T<sub>rr</sub></b>	I <sub>F</sub> = 25A -di/dt = 100 A/μs V <sub>R</sub> = 100V		360	ns
<b>Q<sub>RM</sub></b>			4.0	μC

### TO-247 Outline

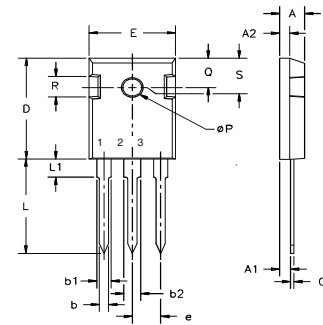

Terminals: 1 - Gate 2 - Drain  
3 - Source Tab - Drain

Dim.	Millimeter		Inches	
	Min.	Max.	Min.	Max.
A	4.7	5.3	.185	.209
A <sub>1</sub>	2.2	2.54	.087	.102
A <sub>2</sub>	2.2	2.6	.059	.098
b	1.0	1.4	.040	.055
b <sub>1</sub>	1.65	2.13	.065	.084
b <sub>2</sub>	2.87	3.12	.113	.123
C	.4	.8	.016	.031
D	20.80	21.46	.819	.845
E	15.75	16.26	.610	.640
e	5.20	5.72	0.205	0.225
L	19.81	20.32	.780	.800
L <sub>1</sub>		4.50		.177
øP	3.55	3.65	.140	.144
Q	5.89	6.40	0.232	0.252
R	4.32	5.49	.170	.216
S	6.15	BSC	.242	BSC

### TO-268 Outline

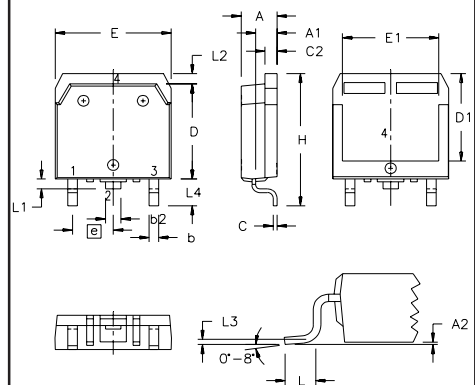

SYM	INCHES		MILLIMETERS	
	MIN	MAX	MIN	MAX
A	.193	.201	4.90	5.10
A1	.106	.114	2.70	2.90
A2	.001	.010	0.02	0.25
b	.045	.057	1.15	1.45
b2	.075	.083	1.90	2.10
C	.016	.026	0.40	0.65
C2	.057	.063	1.45	1.60
D	.543	.551	13.80	14.00
D1	.488	.500	12.40	12.70
E	.624	.632	15.85	16.05
E1	.524	.535	13.30	13.60
e	.215	BSC	5.45	BSC
H	.736	.752	18.70	19.10
L	.094	.106	2.40	2.70
L1	.047	.055	1.20	1.40
L2	.039	.045	1.00	1.15
L3	.010	BSC	0.25	BSC
L4	.150	.161	3.80	4.10

IXYS reserves the right to change limits, test conditions, and dimensions.

**Fig. 1. Output Characteristics  
@ 25 Deg. C**

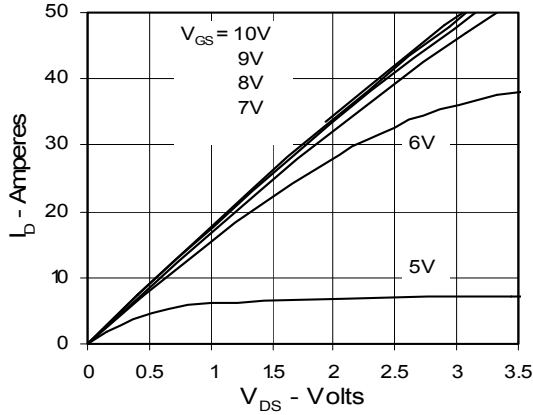

**Fig. 2. Extended Output Characteristics  
@ 25 deg. C**

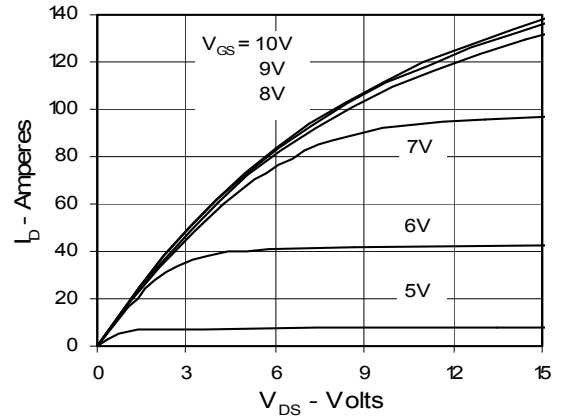

**Fig. 3. Output Characteristics  
@ 125 Deg. C**

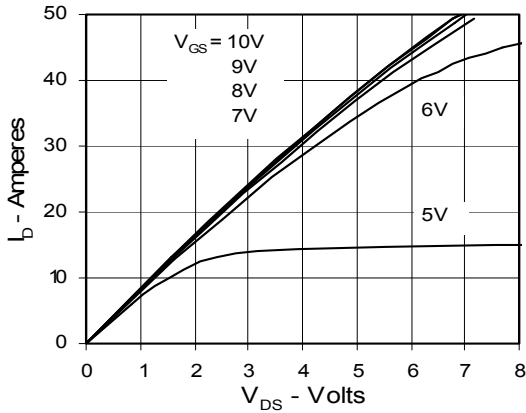

**Fig. 4.  $R_{DS(on)}$  Normalized to  $I_{D25}$  Value vs.  
Junction Temperature**

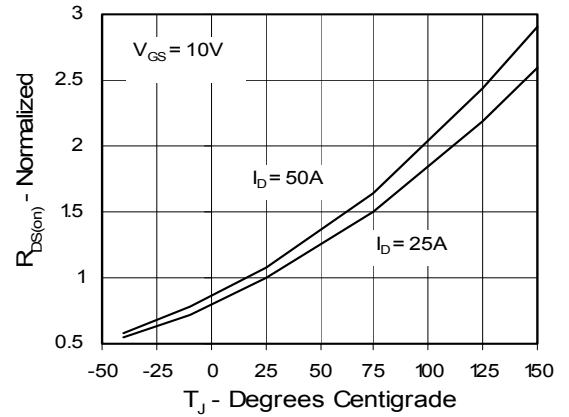

**Fig. 5.  $R_{DS(on)}$  Normalized to  $I_{D25}$   
Value vs.  $I_D$**

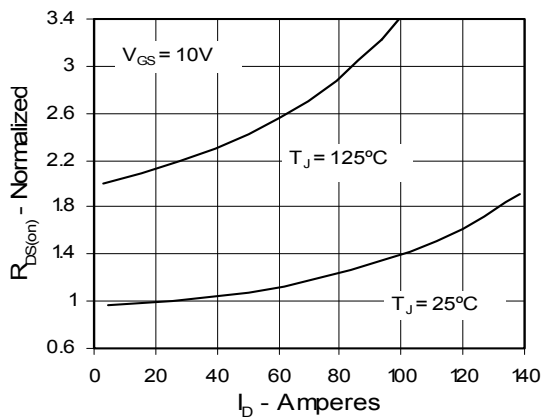

**Fig. 6. Drain Current vs. Case  
Temperature**

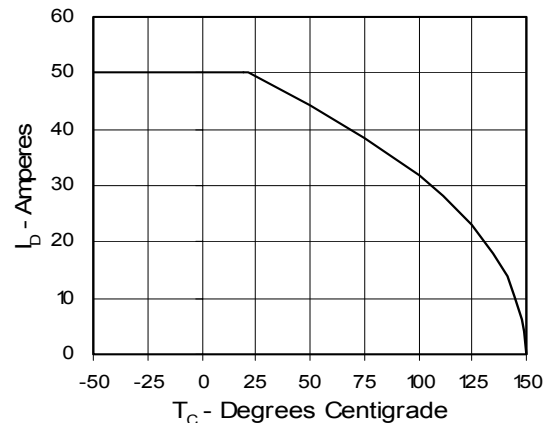

**Fig. 7. Input Admittance**

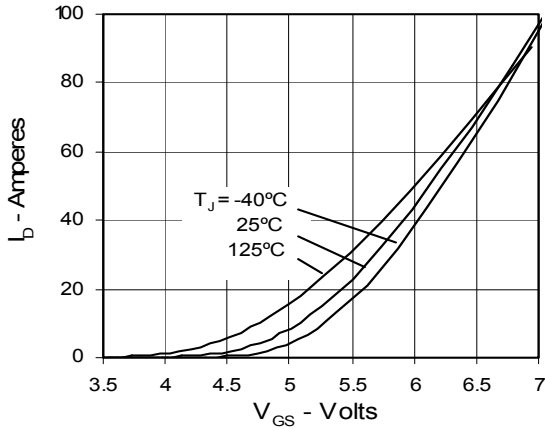

**Fig. 8. Transconductance**

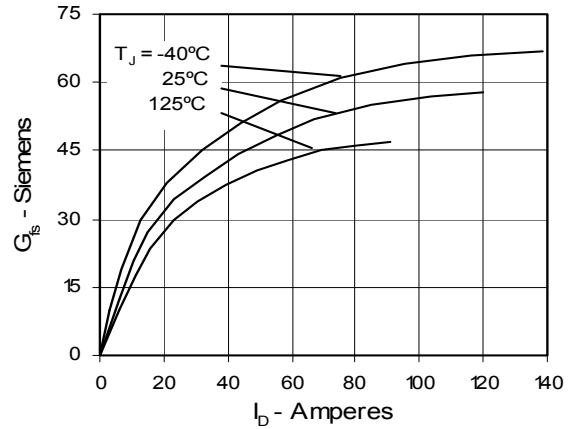

**Fig. 9. Source Current vs. Source-To-Drain Voltage**

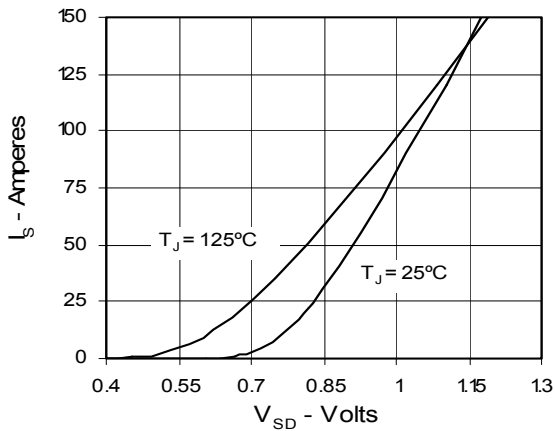

**Fig. 10. Gate Charge**

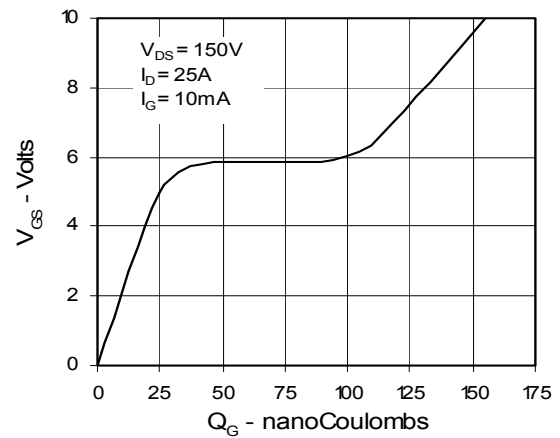

**Fig. 11. Capacitance**

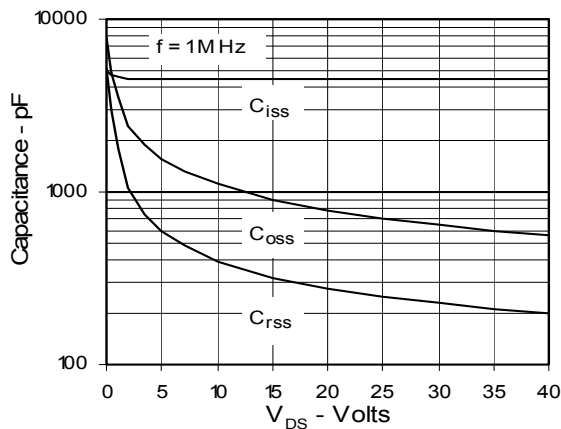

**Fig. 12. Maximum Transient Thermal Resistance**

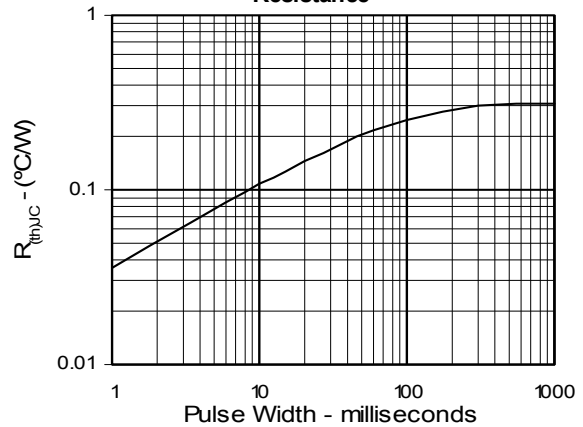

IXYS reserves the right to change limits, test conditions, and dimensions.

IXYS MOSFETs and IGBTs are covered by one or more of the following U.S. patents:

4,835,592 4,881,106 5,017,508 5,049,961 5,187,117 5,486,715 6,306,728B1 6,259,123B1 6,306,728B1  
4,850,072 4,931,844 5,034,796 5,063,307 5,237,481 5,381,025 6,404,065B1 6,162,665 6,534,343