

# Standard Power MOSFET

## IXTH 60N25

$$V_{DSS} = 250 \text{ V}$$

$$I_{D(\text{cont})} = 60 \text{ A}$$

$$R_{DS(\text{on})} = 46 \text{ m}\Omega$$

N-Channel Enhancement Mode

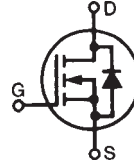

Symbol	Test conditions	Maximum ratings	
$V_{DSS}$	$T_J = 25^\circ\text{C to } 150^\circ\text{C}$	250	V
$V_{DGR}$	$T_J = 25^\circ\text{C to } 150^\circ\text{C}; R_{GS} = 1.0 \text{ M}\Omega$	250	V
$V_{GS}$	Continuous	$\pm 20$	V
$V_{GSM}$	Transient	$\pm 30$	V
$I_{D25}$	$T_C = 25^\circ\text{C}$ MOSFET chip capability	60	A
$I_{DM}$	$T_C = 25^\circ\text{C}$ , pulse width limited by $T_{JM}$	240	A
$I_{AR}$		60	A
$E_{AR}$	$T_C = 25^\circ\text{C}$	50	mJ
$E_{AS}$	$T_C = 25^\circ\text{C}$	1.5	J
$dv/dt$	$I_S \leq I_{DM}$ , $di/dt \leq 100 \text{ A}/\mu\text{s}$ , $V_{DD} \leq V_{DSS}$ $T_J \leq 150^\circ\text{C}$ , $R_G = 2 \Omega$	5	V/ns
$P_D$	$T_C = 25^\circ\text{C}$	400	W
$T_J$		-55 ... +150	$^\circ\text{C}$
$T_{JM}$		150	$^\circ\text{C}$
$T_{stg}$		-55 ... +150	$^\circ\text{C}$
$M_d$	Mounting torque	1.13/10	Nm/lb.in.
<b>Weight</b>	TO-264	6	g
Maximum lead temperature for soldering 1.6 mm (0.062 in.) from case for 10 s		300	$^\circ\text{C}$

TO-247 AD

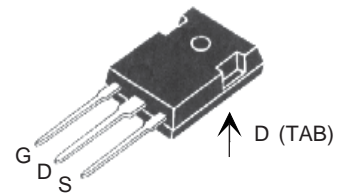

G = Gate      D = Drain  
S = Source    Tab = Drain

### Features

- Low  $R_{DS(\text{on})}$  HDMOS™ process
- Rugged polysilicon gate cell structure
- International standard package JEDEC TO-247 AD
- Fast switching times
- High commutating  $dv/dt$  rating

### Applications

- Motor controls
- DC choppers
- Switched-mode and resonant-mode power supplies
- Uninterruptible Power Supplies (UPS)

### Advantages

- Easy to mount with one screw (isolated mounting screw hole)
- Space savings
- High power density

Symbol	Test Conditions	Characteristic Values		
		Min.	Typ.	Max.
$(T_J = 25^\circ\text{C unless otherwise specified})$				
$V_{DSS}$	$V_{GS} = 0 \text{ V}$ , $I_D = 250 \mu\text{A}$	250		V
$V_{GS(\text{th})}$	$V_{DS} = V_{GS}$ , $I_D = 250 \mu\text{A}$	2.0		4.0 V
$I_{GSS}$	$V_{GS} = \pm 20 \text{ V DC}$ , $V_{DS} = 0$			$\pm 100 \text{ nA}$
$I_{DSS}$	$V_{DS} = V_{DSS}$ $V_{GS} = 0 \text{ V}$			25 $\mu\text{A}$ 250 $\mu\text{A}$
			$T_J = 125^\circ\text{C}$	
$R_{DS(\text{on})}$	$V_{GS} = 10 \text{ V}$ , $I_D = 15 \text{ A}$ Pulse test, $t \leq 300 \text{ ms}$ , duty cycle $d \leq 2\%$			46 $\text{m}\Omega$

Symbol	Test Conditions ( $T_J = 25^\circ\text{C}$ unless otherwise specified)	Characteristic values		
		Min.	Typ.	Max.
$g_{fs}$	$V_{DS} = 10\text{ V}; I_D = 0.5 I_{D25}$ , pulse test	28	36	S
$C_{iss}$ $C_{oss}$ $C_{rss}$	$V_{GS} = 0\text{ V}, V_{DS} = 25\text{ V}, f = 1\text{ MHz}$		4400	pF
			800	pF
			290	pF
$t_{d(on)}$ $t_r$ $t_{d(off)}$ $t_f$	$V_{GS} = 10\text{ V}, V_{DS} = 0.5 V_{DSS}, I_D = 0.5 I_{D25}$ $R_G = 2.0\ \Omega$ (External)		23	ns
			23	ns
			60	ns
			17	ns
$Q_{g(on)}$ $Q_{gs}$ $Q_{gd}$	$V_{GS} = 10\text{ V}, V_{DS} = 0.5 V_{DSS}, I_D = 0.5 I_{D25}$		164	nC
			30	nC
			85	nC
$R_{thJC}$ $R_{thCK}$		0.25	0.31	K/W K/W

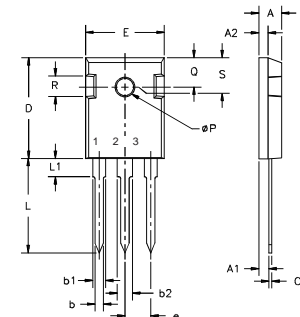
**TO-247 AD Outline**

Terminals: 1 - Gate    2 - Drain  
3 - Source    Tab - Drain

Dim.	Millimeter		Inches	
	Min.	Max.	Min.	Max.
A	4.7	5.3	.185	.209
A <sub>1</sub>	2.2	2.54	.087	.102
A <sub>2</sub>	2.2	2.6	.059	.098
b	1.0	1.4	.040	.055
b <sub>1</sub>	1.65	2.13	.065	.084
b <sub>2</sub>	2.87	3.12	.113	.123
C	.4	.8	.016	.031
D	20.80	21.46	.819	.845
E	15.75	16.26	.610	.640
e	5.20	5.72	0.205	0.225
L	19.81	20.32	.780	.800
L1		4.50		.177
ØP	3.55	3.65	.140	.144
Q	5.89	6.40	0.232	0.252
R	4.32	5.49	.170	.216
S	6.15	BSC	242	BSC

**Source-Drain Diode**
**Ratings and Characteristics**  
 ( $T_J = 25^\circ\text{C}$  unless otherwise specified)

Symbol	Test Conditions	Min.	Typ.	Max.
$I_S$	$V_{GS} = 0\text{ V}$			60 A
$I_{SM}$	Repetitive; pulse width limited by $T_{JM}$			240 A
$V_{SD}$	$I_F = I_S, V_{GS} = 0\text{ V}$ , Pulse test, $t \leq 300\ \mu\text{s}$ , duty cycle $d \leq 2\%$			1.5 V
$t_{rr}$	$I_F = 25\text{ A}, -di/dt = 100\text{ A}/\mu\text{s}, V_R = 100\text{ V}$		300	ns
$Q_{rr}$			3.0	$\mu\text{C}$

IXYS reserves the right to change limits, test conditions, and dimensions.

**Fig. 1. Output Characteristics  
@ 25 Deg. C**

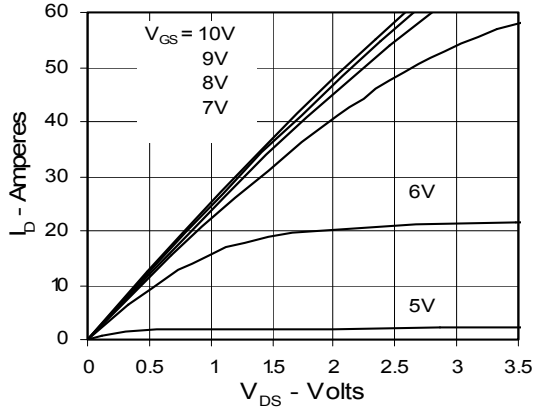

**Fig. 2. Extended Output Characteristics  
@ 25 deg. C**

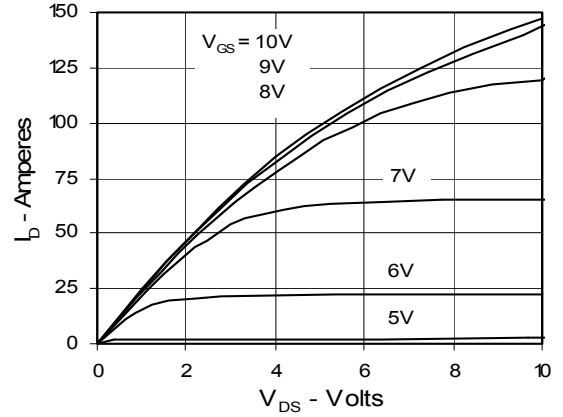

**Fig. 3. Output Characteristics  
@ 125 Deg. C**

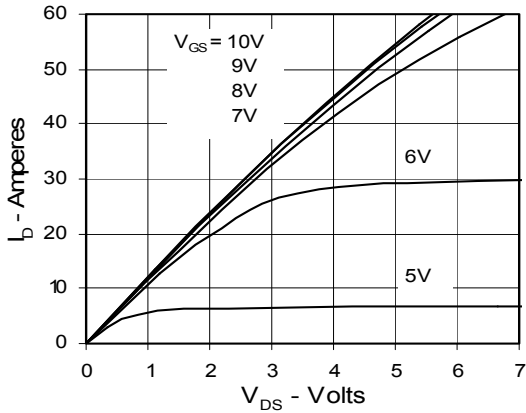

**Fig. 4.  $R_{DS(on)}$  Normalized to  $I_{D25}$  Value vs.  
Junction Temperature**

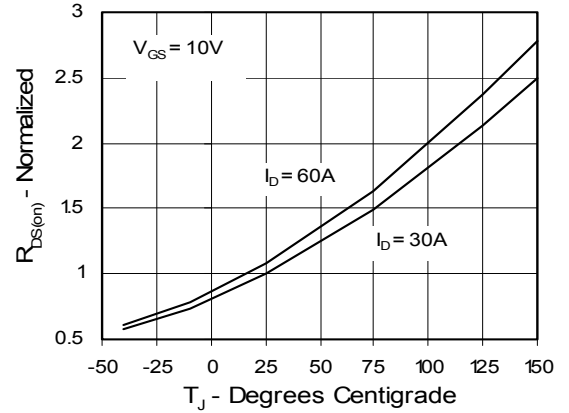

**Fig. 5.  $R_{DS(on)}$  Normalized to  $I_{D25}$   
Value vs.  $I_D$**

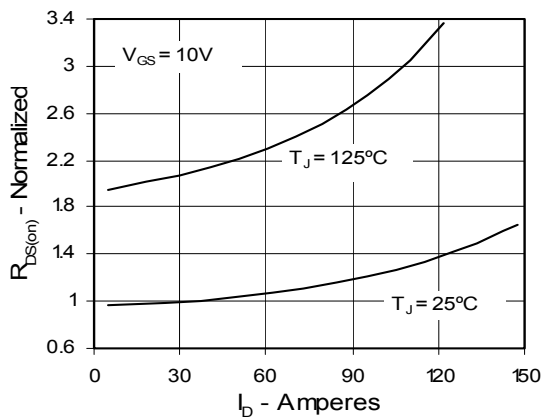

**Fig. 6. Drain Current vs. Case  
Temperature**

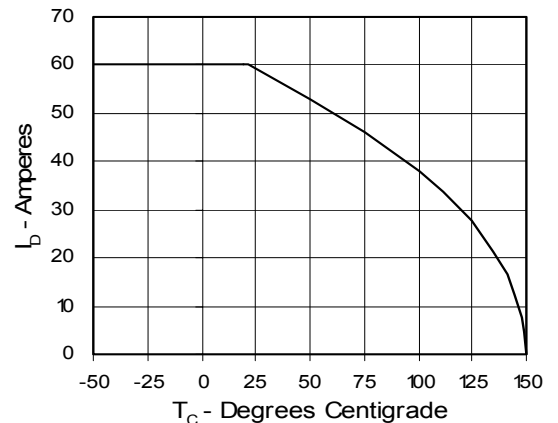

**Fig. 7. Input Admittance**

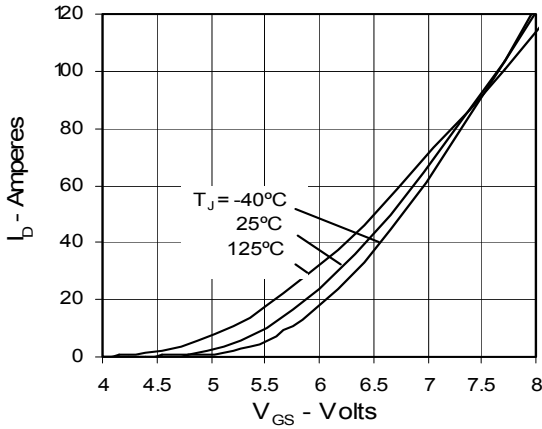

**Fig. 8. Transconductance**

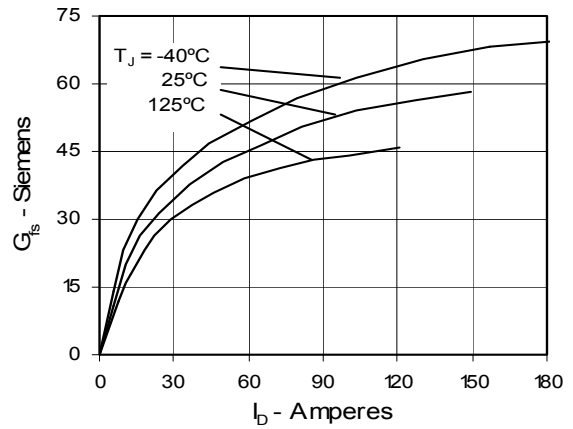

**Fig. 9. Source Current vs. Source-To-Drain Voltage**

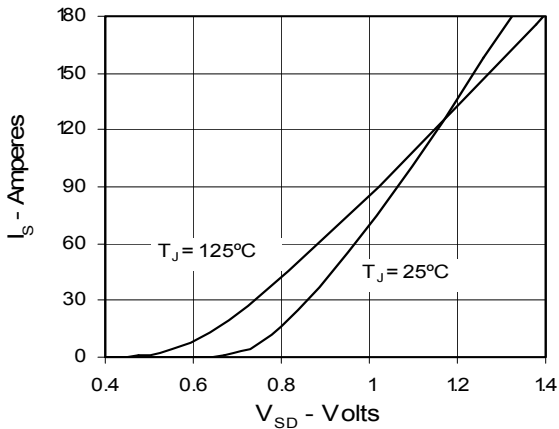

**Fig. 10. Gate Charge**

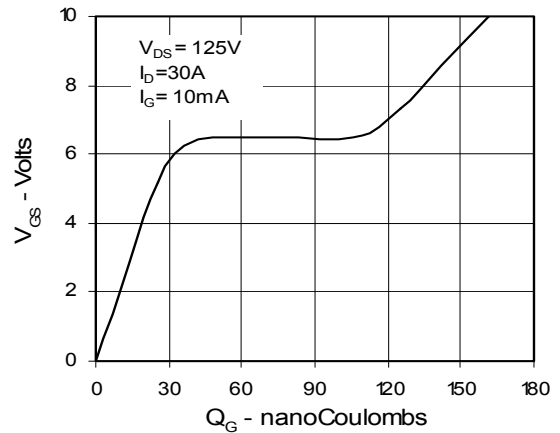

**Fig. 11. Capacitance**

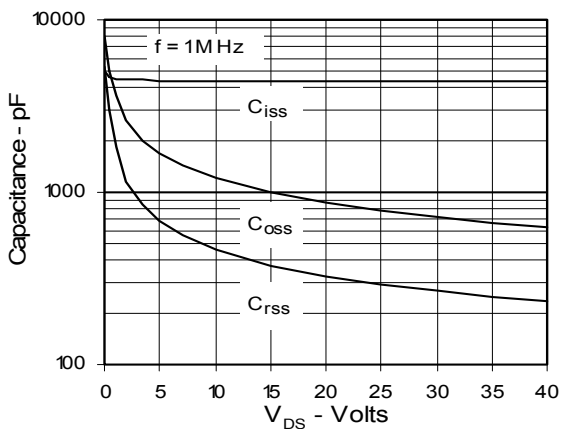

**Fig. 12. Maximum Transient Thermal Resistance**

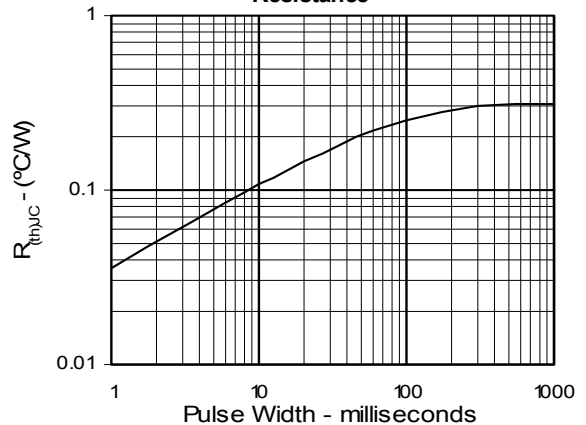

IXYS reserves the right to change limits, test conditions, and dimensions.

IXYS MOSFETs and IGBTs are covered by one or more

4,835,592 4,881,106 5,017,508 5,049,961 5,187,117 5,486,715 6,306,728B1 6,259,123B1 6,306,728B1  
4,850,072 4,931,844 5,034,796 5,063,307 5,237,481 5,381,025 6,404,065B1 6,162,665 6,534,343