

TrenchMV™ IXTC220N075T

Power MOSFET

(Electrically Isolated Back Surface)

$$V_{DSS} = 75 \text{ V}$$

$$I_{D25} = 115 \text{ A}$$

$$R_{DS(on)} \leq 5.0 \text{ m}\Omega$$

N-Channel Enhancement Mode
Avalanche Rated



| Symbol | Test Conditions | Maximum Ratings | |
|---------------|---|-----------------|------------------|
| V_{DSS} | $T_J = 25^\circ\text{C}$ to 175°C | 75 | V |
| V_{DGR} | $T_J = 25^\circ\text{C}$ to 175°C ; $R_{GS} = 1 \text{ M}\Omega$ | 75 | V |
| V_{GSM} | Transient | ± 20 | V |
| I_{D25} | $T_C = 25^\circ\text{C}$ | 115 | A |
| I_{LRMS} | Package Current Limit, RMS | 75 | A |
| I_{DM} | $T_C = 25^\circ\text{C}$, pulse width limited by T_{JM} | 600 | A |
| I_{AR} | $T_C = 25^\circ\text{C}$ | 25 | A |
| E_{AS} | $T_C = 25^\circ\text{C}$ | 1.0 | J |
| dv/dt | $I_S \leq I_{DM}$, $di/dt \leq 100 \text{ A}/\mu\text{s}$, $V_{DD} \leq V_{DSS}$ $T_J \leq 175^\circ\text{C}$, $R_G = 3.3 \Omega$ | 3 | V/ns |
| P_D | $T_C = 25^\circ\text{C}$ | 150 | W |
| T_J | | -55 ... +175 | $^\circ\text{C}$ |
| T_{JM} | | 175 | $^\circ\text{C}$ |
| T_{stg} | | -55 ... +175 | $^\circ\text{C}$ |
| T_L | 1.6 mm (0.062 in.) from case for 10 s | 300 | $^\circ\text{C}$ |
| T_{SOLD} | Plastic body for 10 seconds | 260 | $^\circ\text{C}$ |
| V_{ISOL} | 50/60 Hz, $t = 1$ minute, $I_{ISOL} < 1 \text{ mA}$, RMS | 2500 | V |
| F_C | Mounting force | 11..65/2.5..15 | N/lb. |
| Weight | | 2 | g |

ISOPLUS220 (IXTC)
E153432

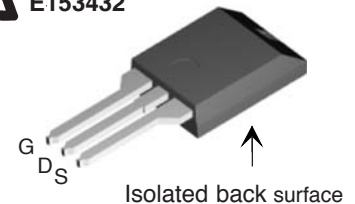

G = Gate
D = Drain
S = Source

Features

- Ultra-low On Resistance
- Unclamped Inductive Switching (UIS) rated
- Low package inductance
 - easy to drive and to protect
- 175 $^\circ\text{C}$ Operating Temperature

Advantages

- Easy to mount
- Space savings
- High power density

Applications

- Automotive
 - Motor Drives
 - 42V Power Bus
 - ABS Systems
- DC/DC Converters and Off-line UPS
- Primary Switch for 24V and 48V Systems
- High Current Switching Applications

| Symbol | Test Conditions ($T_J = 25^\circ\text{C}$ unless otherwise specified) | Characteristic Values | | |
|--------------|---|-----------------------|------|--------------------------------------|
| | | Min. | Typ. | Max. |
| BV_{DSS} | $V_{GS} = 0 \text{ V}$, $I_D = 250 \mu\text{A}$ | 75 | | V |
| $V_{GS(th)}$ | $V_{DS} = V_{GS}$, $I_D = 250 \mu\text{A}$ | 2.0 | | 4.0 V |
| I_{GSS} | $V_{GS} = \pm 20 \text{ V}$, $V_{DS} = 0 \text{ V}$ | | | $\pm 200 \text{ nA}$ |
| I_{DSS} | $V_{DS} = V_{DSS}$ $V_{GS} = 0 \text{ V}$ $T_J = 150^\circ\text{C}$ | | | 5 μA 250 μA |
| $R_{DS(on)}$ | $V_{GS} = 10 \text{ V}$, $I_D = 25 \text{ A}$, Notes 1, 2 | 4.3 | | 5.0 $\text{m}\Omega$ |

| Symbol | Test Conditions | Characteristic Values ($T_J = 25^\circ\text{C}$ unless otherwise specified) | | | |
|--------------|---|---|------|------|-----------------------|
| | | Min. | Typ. | Max. | |
| g_{fs} | $V_{DS} = 10\text{ V}; I_D = 60\text{ A}$, Note 1 | 75 | 120 | | S |
| C_{iss} | $V_{GS} = 0\text{ V}, V_{DS} = 25\text{ V}, f = 1\text{ MHz}$ | | 7700 | | pF |
| C_{oss} | | | 1100 | | pF |
| C_{rss} | | | 230 | | pF |
| $t_{d(on)}$ | $V_{GS} = 10\text{ V}, V_{DS} = 0.5 V_{DSS}, I_D = 25\text{ A}$ | | 29 | | ns |
| t_r | | | 65 | | ns |
| $t_{d(off)}$ | | $R_G = 3.3\ \Omega$ (External) | | 55 | |
| t_f | | | 47 | | ns |
| $Q_{g(on)}$ | $V_{GS} = 10\text{ V}, V_{DS} = 0.5 V_{DSS}, I_D = 25\text{ A}$ | | 165 | | nC |
| Q_{gs} | | | 40 | | nC |
| Q_{gd} | | | 50 | | nC |
| R_{thJC} | | | | | 1.0°C/W |
| R_{thCS} | | 0.5 | | | $^\circ\text{C/W}$ |

Source-Drain Diode

| Symbol | Test Conditions | Characteristic Values ($T_J = 25^\circ\text{C}$ unless otherwise specified) | | | |
|----------|--|---|------|------|----|
| | | Min. | Typ. | Max. | |
| I_S | $V_{GS} = 0\text{ V}$ | | | 220 | A |
| I_{SM} | Pulse width limited by T_{JM} | | | 600 | A |
| V_{SD} | $I_F = 25\text{ A}, V_{GS} = 0\text{ V}$, Note 1 | | | 1.0 | V |
| t_{rr} | $I_F = 25\text{ A}, -di/dt = 100\text{ A}/\mu\text{s}$ $V_R = 40\text{ V}, V_{GS} = 0\text{ V}$ | | 50 | | ns |

- Notes: 1. Pulse test: $t \leq 300\ \mu\text{s}$, duty cycle $d \leq 2\%$;
2. Drain and Source Kelvin contacts must be located less than 5 mm from the plastic body.

ISOPLUS220 (IXTC) Outline

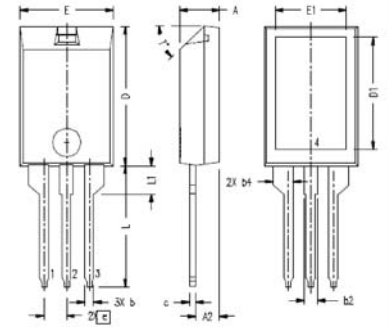

1. Gate 2. Drain
3. Source

Note: Bottom heatsink (Pin 4) is electrically isolated from Pins 1, 2, and 3.

| SYM | INCHES | | MILLIMETERS | |
|-----|------------|------|-------------|-------|
| | MIN | MAX | MIN | MAX |
| A | .157 | .197 | 4.00 | 5.00 |
| A2 | .098 | .118 | 2.50 | 3.00 |
| b | .035 | .051 | 0.90 | 1.30 |
| b2 | .049 | .065 | 1.25 | 1.65 |
| b4 | .093 | .100 | 2.35 | 2.55 |
| c | .028 | .039 | 0.70 | 1.00 |
| D | .591 | .630 | 15.00 | 16.00 |
| D1 | .472 | .512 | 12.00 | 13.00 |
| E | .394 | .433 | 10.00 | 11.00 |
| E1 | .295 | .335 | 7.50 | 8.50 |
| e | .100 BASIC | | 2.55 BASIC | |
| L | .512 | .571 | 13.00 | 14.50 |
| L1 | .118 | .138 | 3.00 | 3.50 |
| T* | | | 42.5° | 47.5° |

PRELIMINARY TECHNICAL INFORMATION

The product presented herein is under development. The Technical Specifications offered are derived from data gathered during objective characterizations of preliminary engineering lots; but also may yet contain some information supplied during a pre-production design evaluation. IXYS reserves the right to change limits, test conditions, and dimensions without notice.

IXYS reserves the right to change limits, test conditions, and dimensions.

| | | | | | | | | | |
|--|-----------|-----------|-----------|-----------|--------------|--------------|-------------|------------|--------------|
| IXYS MOSFETs and IGBTs are covered by one or more of the following U.S. patents: | 4,835,592 | 4,931,844 | 5,049,961 | 5,237,481 | 6,162,665 | 6,404,065 B1 | 6,683,344 | 6,727,585 | 7,005,734 B2 |
| | 4,850,072 | 5,017,508 | 5,063,307 | 5,381,025 | 6,259,123 B1 | 6,534,343 | 6,710,405B2 | 6,759,692 | 7,063,975 B2 |
| | 4,881,106 | 5,034,796 | 5,187,117 | 5,486,715 | 6,306,728 B1 | 6,583,505 | 6,710,463 | 6771478 B2 | 7,071,537 |

Fig. 1. Output Characteristics @ 25°C

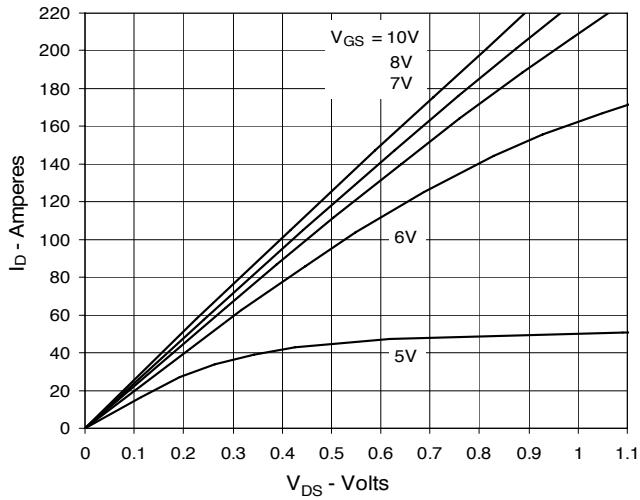

Fig. 2. Extended Output Characteristics @ 25°C

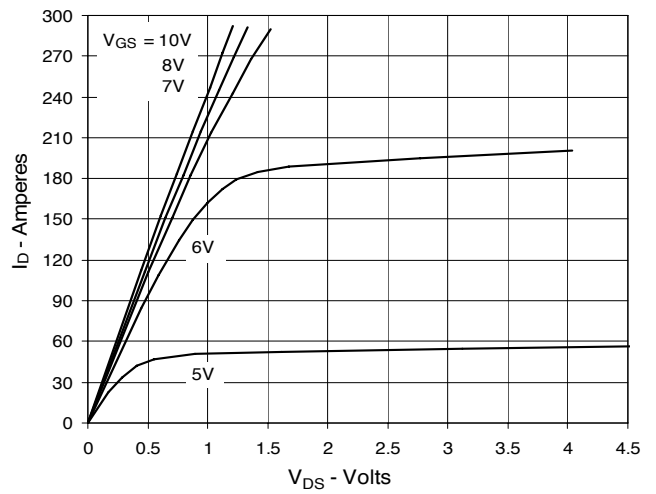

Fig. 3. Output Characteristics @ 150°C

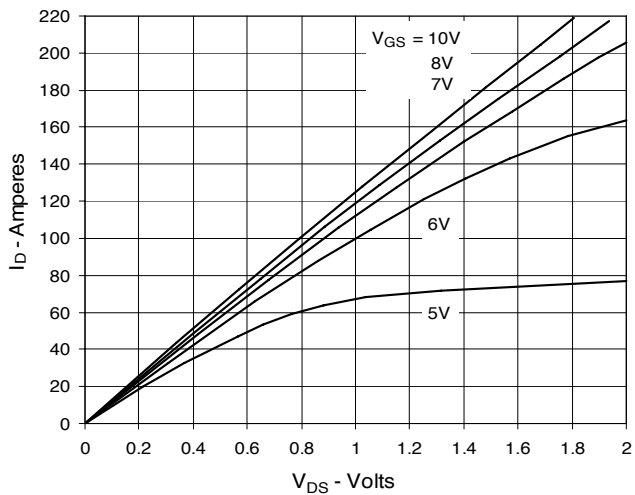

Fig. 4. $R_{DS(on)}$ Normalized to $I_D = 110A$ Value vs. Junction Temperature

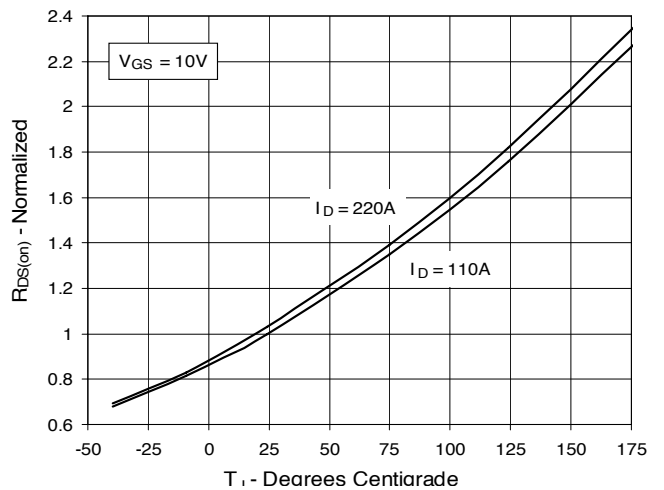

Fig. 5. $R_{DS(on)}$ Normalized to $I_D = 110A$ Value vs. Drain Current

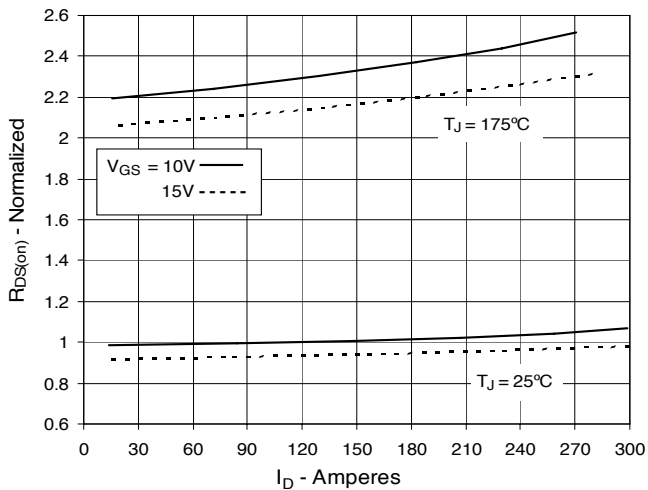

Fig. 6. Drain Current vs. Case Temperature

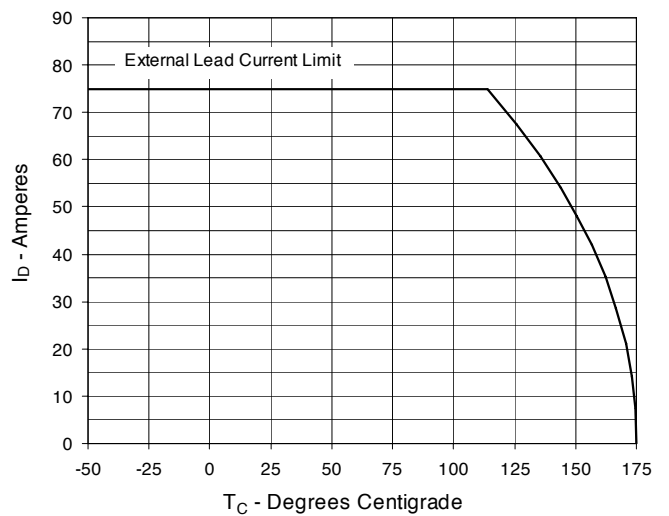

Fig. 7. Input Admittance

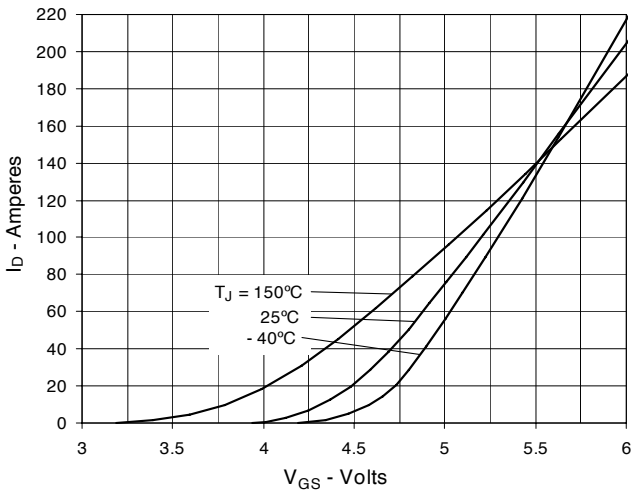

Fig. 8. Transconductance

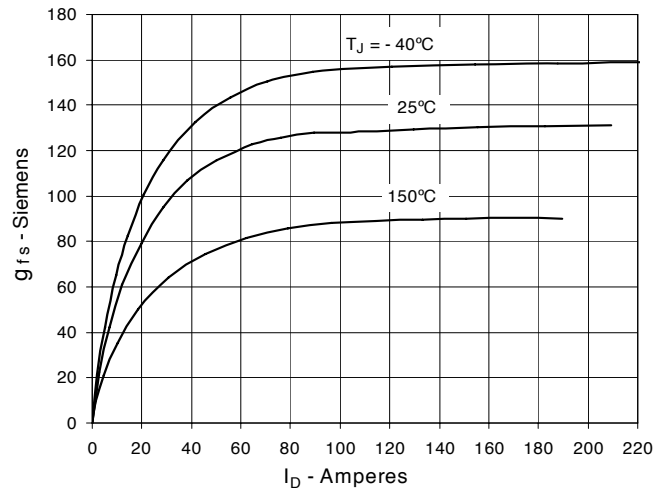

Fig. 9. Forward Voltage Drop of Intrinsic Diode

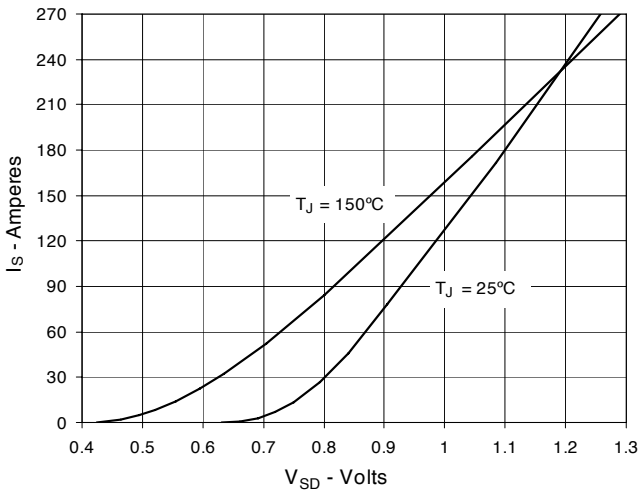

Fig. 10. Gate Charge

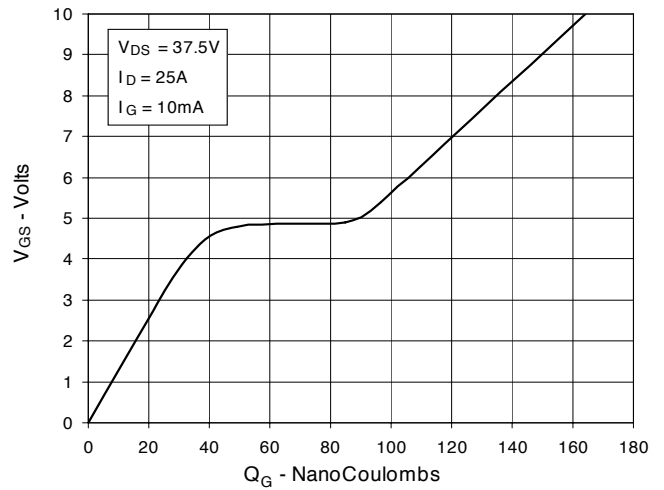

Fig. 11. Capacitance

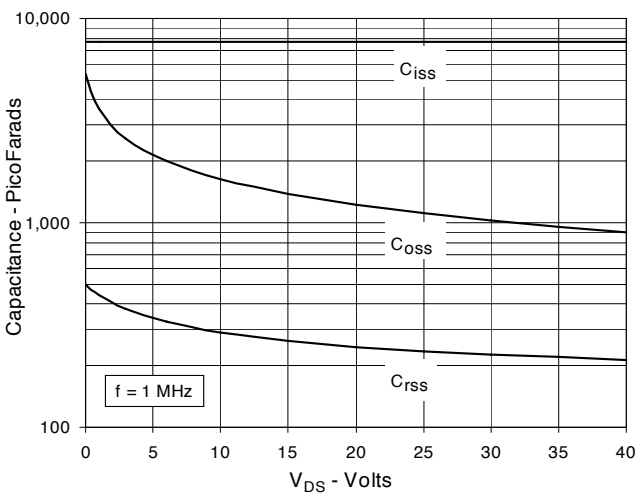
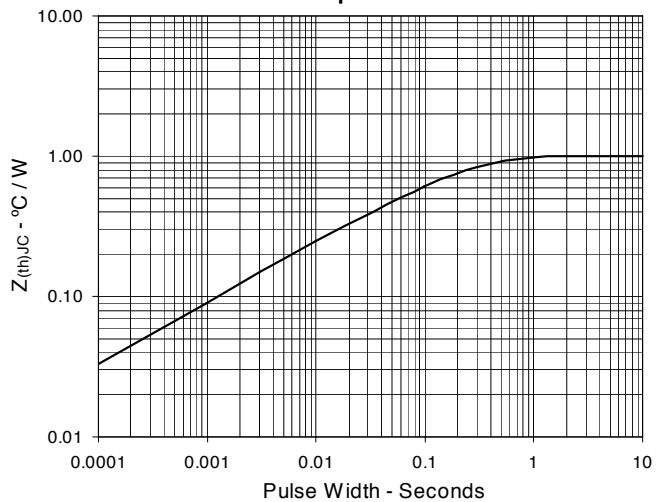
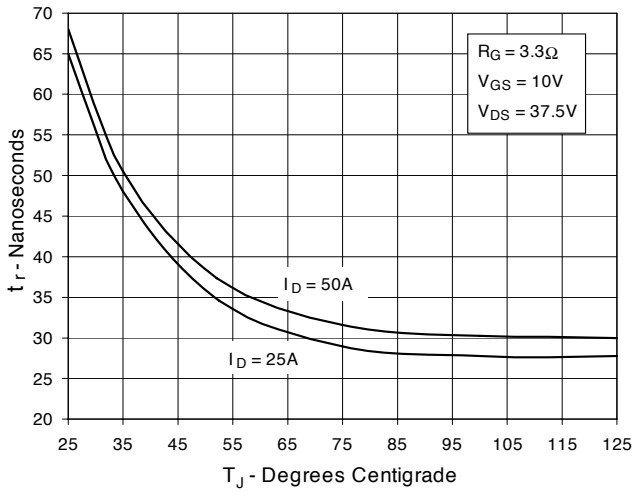

Fig. 12. Maximum Transient Thermal Impedance



**Fig. 13. Resistive Turn-on
Rise Time vs. Junction Temperature**



**Fig. 14. Resistive Turn-on
Rise Time vs. Drain Current**

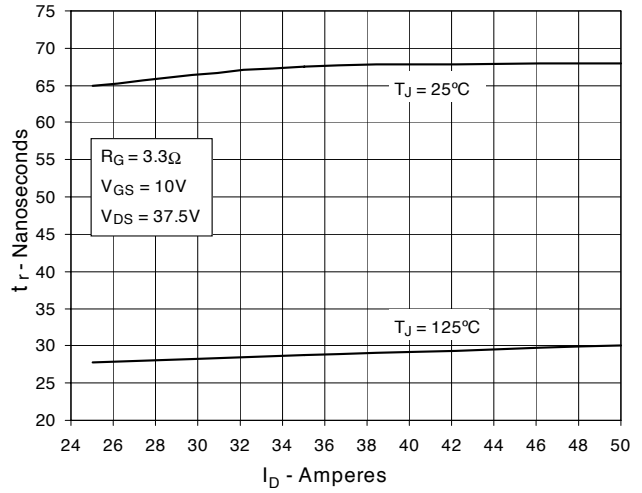

**Fig. 15. Resistive Turn-on
Switching Times vs. Gate Resistance**

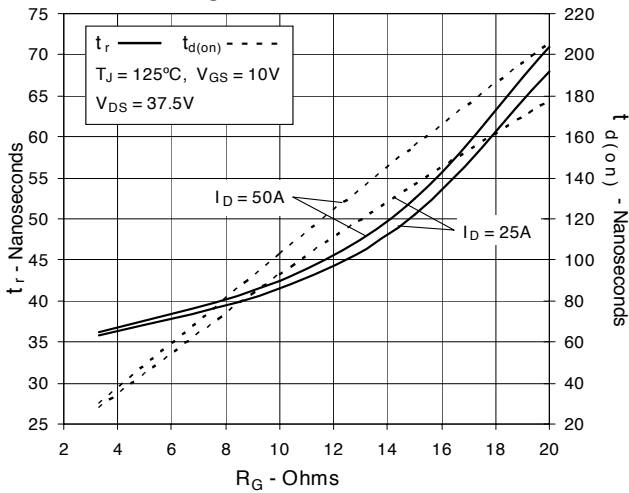

**Fig. 16. Resistive Turn-off
Switching Times vs. Junction Temperature**

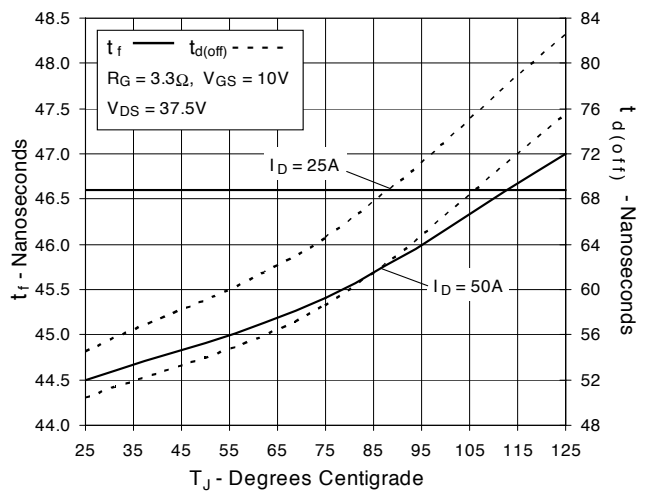

**Fig. 17. Resistive Turn-off
Switching Times vs. Drain Current**

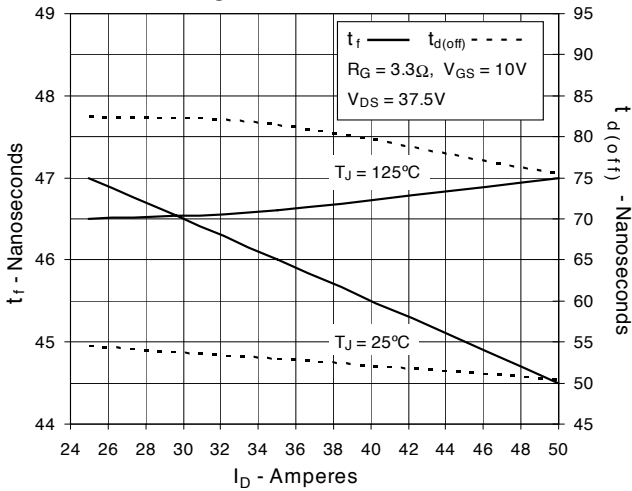

**Fig. 18. Resistive Turn-off
Switching Times vs. Gate Resistance**

