

HiPerFET™ Power MOSFETs Q-Class

IXFH 66N20Q
IXFT 66N20Q

$V_{DSS} = 200 \text{ V}$
 $I_{D25} = 66 \text{ A}$
 $R_{DS(on)} = 40 \text{ m}\Omega$

$t_{rr} \leq 200 \text{ ns}$

N-Channel Enhancement Mode
Avalanche Rated High dv/dt, Low Q_g

Preliminary data sheet

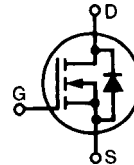

Symbol	Test Conditions	Maximum Ratings	
V_{DSS}	$T_J = 25^\circ\text{C}$ to 150°C	200	V
V_{DGR}	$T_J = 25^\circ\text{C}$ to 150°C ; $R_{GS} = 1 \text{ M}\Omega$	200	V
V_{GS}	Continuous	± 30	V
V_{GSM}	Transient	± 40	V
I_{D25}	$T_C = 25^\circ\text{C}$	66	A
I_{DM}	$T_C = 25^\circ\text{C}$, pulse width limited by T_{JM}	264	A
I_{AR}	$T_C = 25^\circ\text{C}$	66	A
E_{AR}	$T_C = 25^\circ\text{C}$	40	mJ
E_{AS}	$T_C = 25^\circ\text{C}$	1.5	J
dv/dt	$I_S \leq I_{DM}$, $di/dt \leq 100 \text{ A}/\mu\text{s}$, $V_{DD} \leq V_{DSS}$, $T_J \leq 150^\circ\text{C}$, $R_G = 2 \Omega$	20	V/ns
P_D	$T_C = 25^\circ\text{C}$	400	W
T_J		-55 ... +150	$^\circ\text{C}$
T_{JM}		150	$^\circ\text{C}$
T_{stg}		-55 ... +150	$^\circ\text{C}$
T_L	1.6 mm (0.062 in.) from case for 10 s	300	$^\circ\text{C}$
M_d	Mounting torque	1.13/10 Nm/lb.in.	
Weight	TO-247	6	g
	TO-268	4	g

TO-268 (D3) (IXFT) Case Style

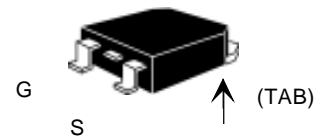

TO-247 AD

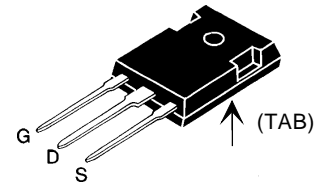

G = Gate D = Drain
S = Source TAB = Drain

Features

- IXYS advanced low Q_g process
- International standard packages
- Low gate charge and capacitance
 - easier to drive
 - faster switching
- Low $R_{DS(on)}$
- Unclamped Inductive Switching (UIS) rated
- Molding epoxies meet UL 94 V-0 flammability classification

Advantages

- Easy to mount
- Space savings
- High power density

Symbol	Test Conditions ($T_J = 25^\circ\text{C}$, unless otherwise specified)	Characteristic Values		
		Min.	Typ.	Max.
V_{DSS}	$V_{GS} = 0 \text{ V}$, $I_D = 250 \mu\text{A}$	200		V
$V_{GS(th)}$	$V_{DS} = V_{GS}$, $I_D = 4 \text{ mA}$	2.0		V
I_{GSS}	$V_{GS} = \pm 30 \text{ V}_{DC}$, $V_{DS} = 0$			$\pm 100 \text{ nA}$
I_{DSS}	$V_{DS} = V_{DSS}$, $T_J = 25^\circ\text{C}$			25 μA
	$V_{GS} = 0 \text{ V}$, $T_J = 125^\circ\text{C}$			1 mA
$R_{DS(on)}$	$V_{GS} = 10 \text{ V}$, $I_D = 0.5 I_{D25}$ Pulse test, $t \leq 300 \mu\text{s}$, duty cycle $d \leq 2\%$			40 m Ω

Symbol	Test Conditions	Characteristic Values ($T_J = 25^\circ\text{C}$, unless otherwise specified)		
		Min.	Typ.	Max.
g_{fs}	$V_{DS} = 10\text{ V}$; $I_D = 0.5 I_{D25}$, pulse test	30	45	S
C_{iss}	$V_{GS} = 0\text{ V}$, $V_{DS} = 25\text{ V}$, $f = 1\text{ MHz}$		3700	pF
C_{oss}			860	pF
C_{rss}			260	pF
$t_{d(on)}$	$V_{GS} = 10\text{ V}$, $V_{DS} = 0.5 V_{DSS}$, $I_D = 0.5 I_{D25}$ $R_G = 2.0\ \Omega$ (External)		20	ns
t_r			18	ns
$t_{d(off)}$			50	ns
t_f			14	ns
$Q_{g(on)}$	$V_{GS} = 10\text{ V}$, $V_{DS} = 0.5 V_{DSS}$, $I_D = 0.5 I_{D25}$		105	nC
Q_{gs}			20	nC
Q_{gd}			44	nC
R_{thJC}			0.31	K/W
R_{thCK}	(TO-247)		0.25	K/W

Symbol	Test Conditions	Characteristic Values ($T_J = 25^\circ\text{C}$, unless otherwise specified)		
		min.	typ.	max.
I_S	$V_{GS} = 0\text{ V}$			66 A
I_{SM}	Repetitive;			264 A
V_{SD}	$I_F = I_S$, $V_{GS} = 0\text{ V}$, Pulse test, $t \leq 300\ \mu\text{s}$, duty cycle $d \leq 2\%$			1.5 V
t_{rr}	$I_F = 25\text{ A}$, $-di/dt = 100\text{ A}/\mu\text{s}$, $V_R = 100\text{ V}$		0.6	200 ns
Q_{RM}			7	μC
I_{RM}				A

Min. Recommended Footprint

Dimensions in mm and inches

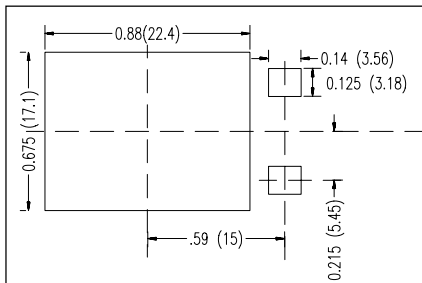

TO-247 AD Outline

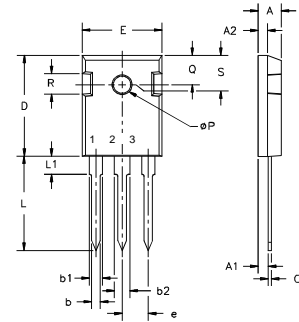

Terminals: 1 - Gate 2 - Drain
3 - Source Tab - Drain

Dim.	Millimeter		Inches	
	Min.	Max.	Min.	Max.
A	4.7	5.3	.185	.209
A ₁	2.2	2.54	.087	.102
A ₂	2.2	2.6	.059	.098
b	1.0	1.4	.040	.055
b ₁	1.65	2.13	.065	.084
b ₂	2.87	3.12	.113	.123
C	.4	.8	.016	.031
D	20.80	21.46	.819	.845
E	15.75	16.26	.610	.640
e	5.20	5.72	0.205	0.225
L	19.81	20.32	.780	.800
L ₁		4.50		.177
ϕP	3.55	3.65	.140	.144
Q	5.89	6.40	0.232	0.252
R	4.32	5.49	.170	.216
S	6.15	BSC	242	BSC

TO-268 Outline

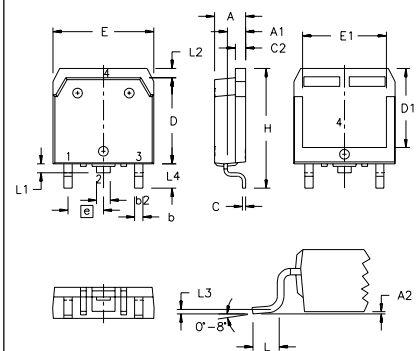

SYM	INCHES		MILLIMETERS	
	MIN	MAX	MIN	MAX
A	.193	.201	4.90	5.10
A ₁	.106	.114	2.70	2.90
A ₂	.001	.010	0.02	0.25
b	.045	.057	1.15	1.45
b ₂	.075	.083	1.90	2.10
C	.016	.026	0.40	0.65
C ₂	.057	.063	1.45	1.60
D	.543	.551	13.80	14.00
D ₁	.488	.500	12.40	12.70
E	.624	.632	15.85	16.05
E ₁	.524	.535	13.30	13.60
e	.215 BSC		5.45 BSC	
H	.736	.752	18.70	19.10
L	.094	.106	2.40	2.70
L ₁	.047	.055	1.20	1.40
L ₂	.039	.045	1.00	1.15
L ₃	.010 BSC		0.25 BSC	
L ₄	.150	.161	3.80	4.10

IXYS reserves the right to change limits, test conditions, and dimensions.

IXYS MOSFETs and IGBTs are covered by one or more of the following U.S. patents:

4,835,592 4,881,106 5,017,508 5,049,961 5,187,117 5,486,715 6,306,728B1 6,259,123B1 6,306,728B1
4,850,072 4,931,844 5,034,796 5,063,307 5,237,481 5,381,025 6,404,065B1 6,162,665 6,534,343

Fig. 1. Output Characteristics
@ 25 Deg. C

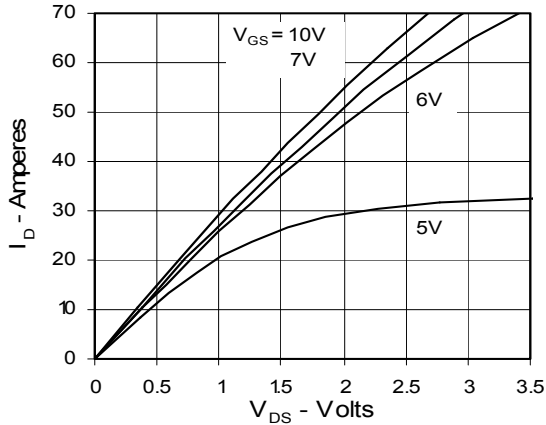

Fig. 2. Extended Output Characteristics
@ 25 deg. C

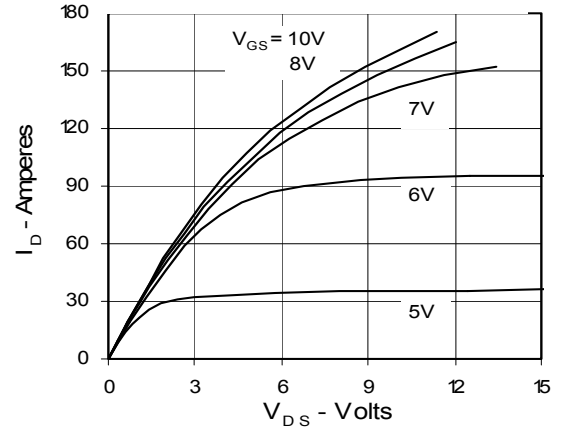

Fig. 3. Output Characteristics
@ 125 Deg. C

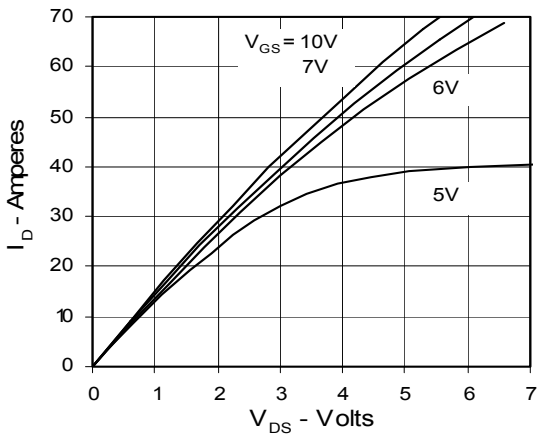

Fig. 4. R_DS(on) Normalized to I_D25 Value vs. Junction Temperature

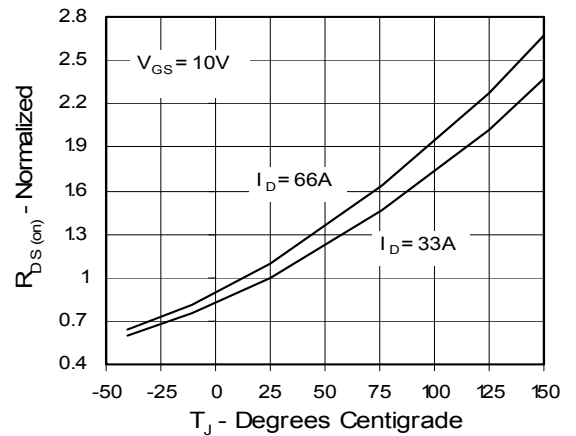

Fig. 5. R_DS(on) Normalized to I_D25 Value vs. I_D

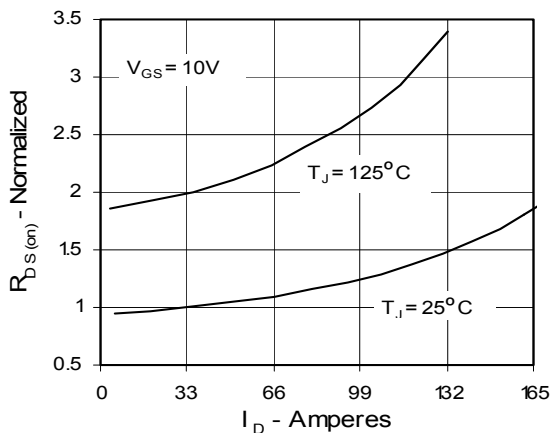

Fig. 6. Drain Current vs. Case Temperature

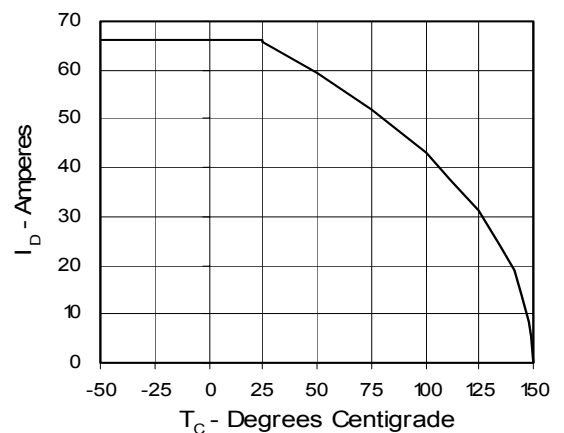

Fig. 7. Input Admittance

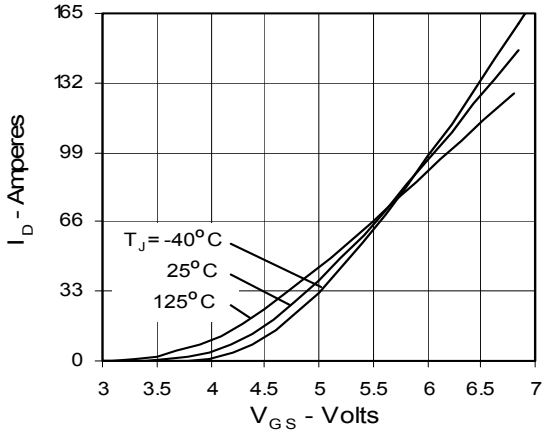

Fig. 8. Transconductance

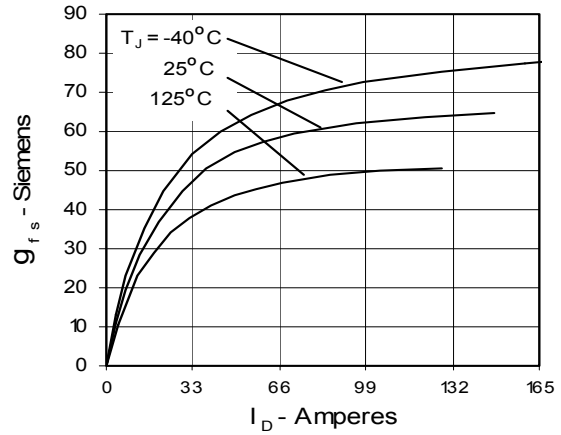

Fig. 9. Source Current vs. Source-To-Drain Voltage

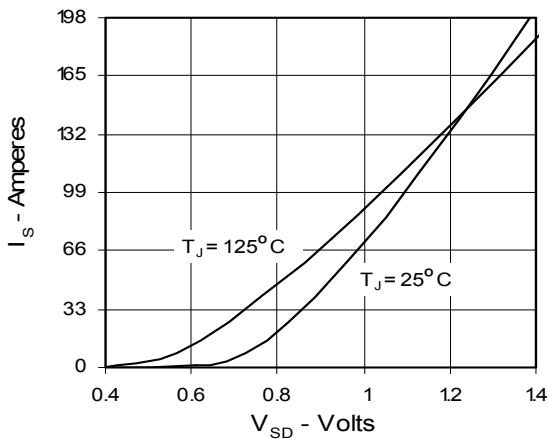

Fig. 10. Gate Charge

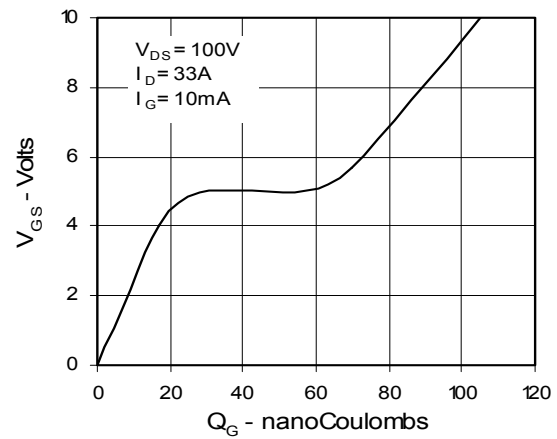

Fig. 11. Capacitance

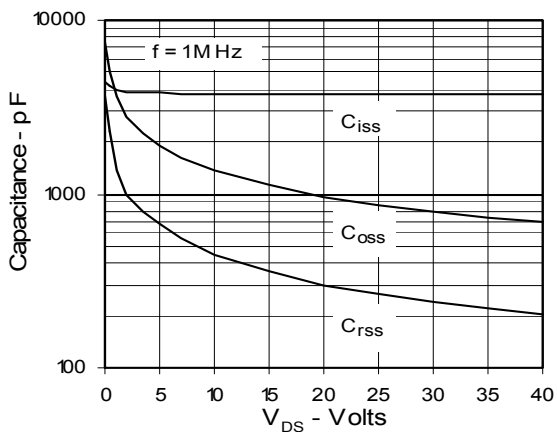
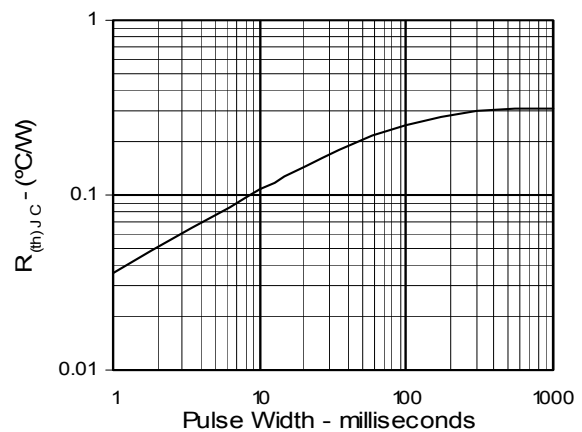

Fig. 12. Maximum Transient Thermal Resistance



IXYS reserves the right to change limits, test conditions, and dimensions.

IXYS MOSFETs and IGBTs are covered by one or more of the following U.S. patents:

4,835,592 4,881,106 5,017,508 5,049,961 5,187,117 5,486,715 6,306,728B1 6,259,123B1 6,306,728B1
4,850,072 4,931,844 5,034,796 5,063,307 5,237,481 5,381,025 6,404,065B1 6,162,665 6,534,343