

High Current MegaMOS™ FET

IXTK 62N25

$$\begin{aligned} V_{DSS} &= 250 \text{ V} \\ I_{D25} &= 62 \text{ A} \\ R_{DS(on)} &= 35 \text{ m}\Omega \end{aligned}$$

N-Channel Enhancement Mode

Preliminary Data Sheet

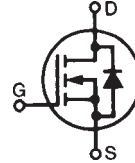

Symbol	Test conditions	Maximum ratings	
V_{DSS}	$T_J = 25^\circ\text{C}$ to 150°C	250	V
V_{DGR}	$T_J = 25^\circ\text{C}$ to 150°C ; $R_{GS} = 1.0 \text{ M}\Omega$	250	V
V_{GS}	Continuous	± 20	V
V_{GSM}	Transient	± 30	V
I_{D25}	$T_C = 25^\circ\text{C}$	62	A
I_{DM}	$T_C = 25^\circ\text{C}$, pulse width limited by T_{JM}	248	A
I_{AR}	$T_C = 25^\circ\text{C}$	62	A
E_{AR}	$T_C = 25^\circ\text{C}$	45	mJ
E_{AS}	$T_C = 25^\circ\text{C}$	1.5	J
dv/dt	$I_S \leq I_{DM}$, $di/dt \leq 100 \text{ A}/\mu\text{s}$, $V_{DD} \leq V_{DSS}$ $T_J \leq 150^\circ\text{C}$, $R_G = 2 \Omega$	5	V/ns
P_D	$T_C = 25^\circ\text{C}$	390	W
T_J		-55 ... +150	$^\circ\text{C}$
T_{JM}		150	$^\circ\text{C}$
T_{stg}		-55 ... +150	$^\circ\text{C}$
T_L	1.6 mm (0.063 in.) from case for 10 s	300	$^\circ\text{C}$
M_d	Mounting torque	0.7/6	Nm/lb.in.
Weight	TO-264	10	g

TO-264

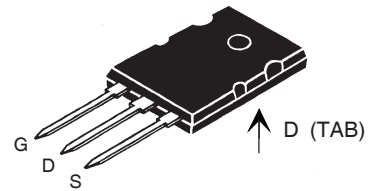

G = Gate D = Drain
S = Source Tab = Drain

Features

- Low $R_{DS(on)}$ HDMOS™ process
- Rugged polysilicon gate cell structure
- International standard package
- Fast switching times

Applications

- Motor controls
- DC choppers
- Switched-mode power supplies

Advantages

- Easy to mount with one screw (isolated mounting screw hole)
- Space savings
- High power density

Symbol	Test Conditions	Characteristic Values		
		Min.	Typ.	Max.
V_{DSS}	$V_{GS} = 0 \text{ V}$, $I_D = 1 \text{ mA}$	250		V
$V_{GS(th)}$	$V_{DS} = V_{GS}$, $I_D = 250 \mu\text{A}$	2.0		4.0 V
I_{GSS}	$V_{GS} = \pm 20 \text{ V DC}$, $V_{DS} = 0$			$\pm 100 \text{ nA}$
I_{DSS}	$V_{DS} = V_{DSS}$, $T_J = 25^\circ\text{C}$ $V_{GS} = 0 \text{ V}$, $T_J = 125^\circ\text{C}$			50 μA 2 mA
$R_{DS(on)}$	$V_{GS} = 10 \text{ V}$, $I_D = 0.5 I_{D25}$ Pulse test, $t \leq 300 \text{ ms}$, duty cycle $d \leq 2\%$			35 m Ω

Symbol	Test Conditions	Characteristic values		
		Min.	Typ.	Max.
g_{fs}	$V_{DS} = 10\text{ V}; I_D = 0.5 I_{D25}$, pulse test	35	47	S
C_{iss} C_{oss} C_{rss}	$V_{GS} = 0\text{ V}, V_{DS} = 25\text{ V}, f = 1\text{ MHz}$		5400	pF
			1100	pF
			400	pF
$t_{d(on)}$ t_r $t_{d(off)}$ t_f	$V_{GS} = 10\text{ V}, V_{DS} = 0.5 V_{DSS}, I_D = 0.5 I_{D25}$ $R_G = 1.5\ \Omega$ (External)		30	ns
			25	ns
			115	ns
			15	ns
$Q_{G(on)}$ Q_{GS} Q_{GD}	$V_{GS} = 10\text{ V}, V_{DS} = 0.5 V_{DSS}, I_D = 0.5 I_{D25}$		240	nC
			40	nC
			120	nC
R_{thJC} R_{thCK}		0.15	0.30 K/W	K/W

Source-Drain Diode

Ratings and Characteristics

($T_J = 25^\circ\text{C}$ unless otherwise specified)

Symbol	Test Conditions	Min.	Typ.	Max.
I_S	$V_{GS} = 0\text{ V}$			62 A
I_{SM}	Repetitive; pulse width limited by T_{JM}			248 A
V_{SD}	$I_F = I_S, V_{GS} = 0\text{ V}$, Pulse test, $t \leq 300\ \mu\text{s}$, duty cycle $d \leq 2\%$			1.5 V
t_{rr}	$I_F = 30\text{ A}, -di/dt = 100\text{ A}/\mu\text{s}, V_R = 100\text{ V}$		360	ns
Q_{rr}			6	μC

TO-264 Outline

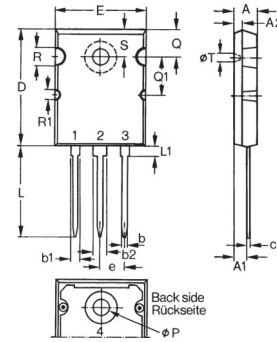

Dim.	Millimeter		Inches	
	Min.	Max.	Min.	Max.
A	4.82	5.13	.190	.202
A1	2.54	2.89	.100	.114
A2	2.00	2.10	.079	.083
b	1.12	1.42	.044	.056
b1	2.39	2.69	.094	.106
b2	2.90	3.09	.114	.122
c	0.53	0.83	.021	.033
D	25.91	26.16	1.020	1.030
E	19.81	19.96	.780	.786
e	5.46BSC		.215BSC	
J	0.00	0.25	.000	.010
K	0.00	0.25	.000	.010
L	20.32	20.83	.800	.820
L1	2.29	2.59	.090	.102
P	3.17	3.66	.125	.144
Q	6.07	6.27	.239	.247
Q1	8.38	8.69	.330	.342
R	3.81	4.32	.150	.170
R1	1.78	2.29	.070	.090
S	6.04	6.30	.238	.248
T	1.57	1.83	.062	.072

Note: IXTK62N25 MOSFET will be supplied in either package outline at the discretion of the vendor.

TO-264 Alternate Outline

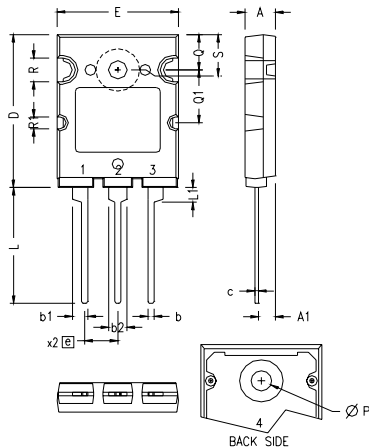

SYM	INCHES		MILLIMETERS	
	MIN	MAX	MIN	MAX
A	.185	.209	4.70	5.30
A1	.102	.118	2.60	3.00
b	.035	.049	0.90	1.25
b1	.091	.106	2.30	2.70
b2	.110	.126	2.80	3.20
c	.020	.033	0.50	0.85
D	1.012	1.035	25.70	26.30
E	.776	.799	19.70	20.30
e	.215BSC		5.46 BSC	
L	.768	.807	19.50	20.50
L1	.091	.106	2.30	2.70
ϕP	.122	.138	3.10	3.50
Q	.228	.244	5.80	6.20
Q1	.346	.362	8.80	9.20
ϕR	.150	.165	3.80	4.20
$\phi R1$.071	.087	1.80	2.20
S	.228	.244	5.80	6.20

Note: Leads and tab are solder

IXYS reserves the right to change limits, test conditions, and dimensions.

IXYS MOSFETs and IGBTs are covered by one or more of the following U.S. patents:

4,835,592	4,881,106	5,017,508	5,049,961	5,187,117	5,381,025	6,162,665	6,306,728 B1	6,534,343	6,683,344
4,850,072	4,931,844	5,034,796	5,063,307	5,237,481	5,486,715	6,259,123 B1	6,404,065 B1	6,583,505	6,710,405 B2

**Fig. 1. Output Characteristics
@ 25 Deg. C**

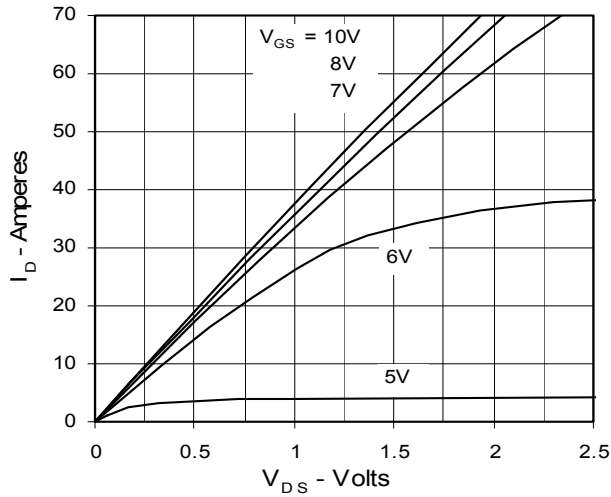

**Fig. 2. Extended Output Characteristics
@ 25 deg. C**

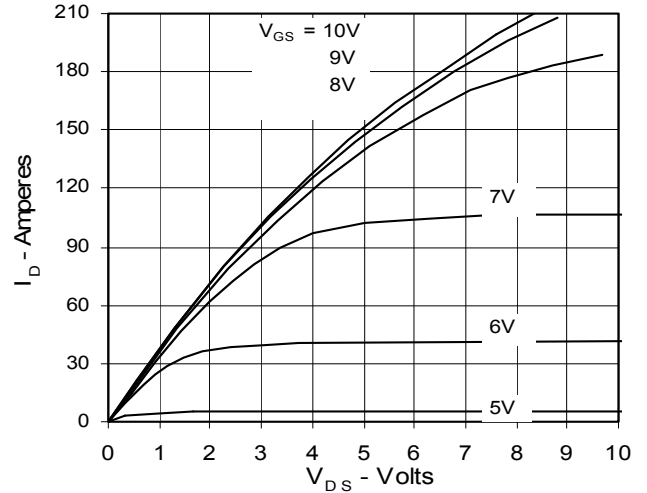

**Fig. 3. Output Characteristics
@ 125 Deg. C**

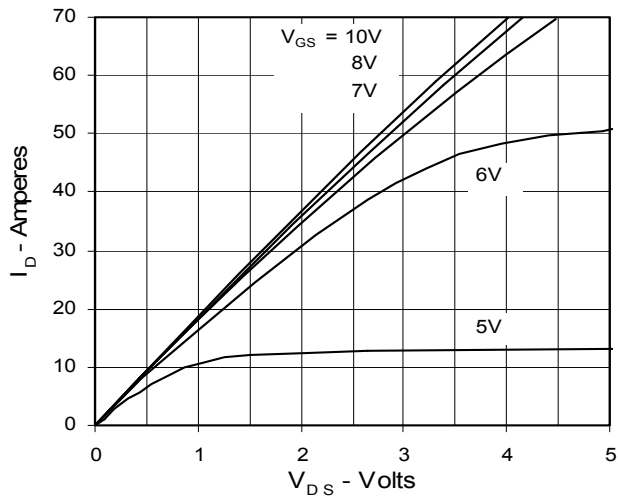

**Fig. 4. $R_{DS(on)}$ Normalized to I_{D25} Value vs.
Junction Temperature**

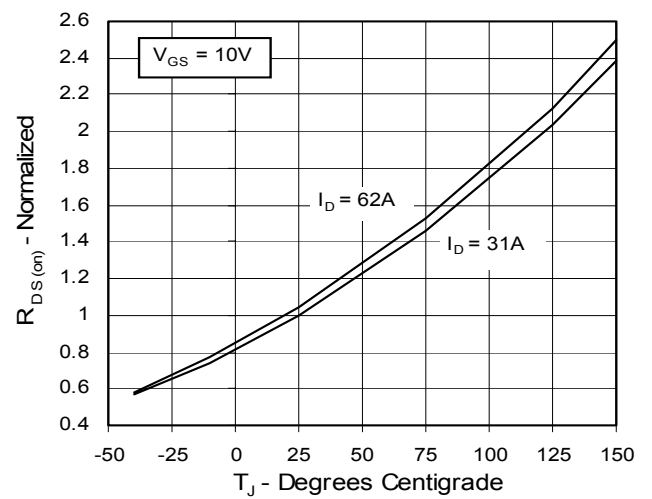

**Fig. 5. $R_{DS(on)}$ Normalized to I_{D25}
Value vs. I_D**

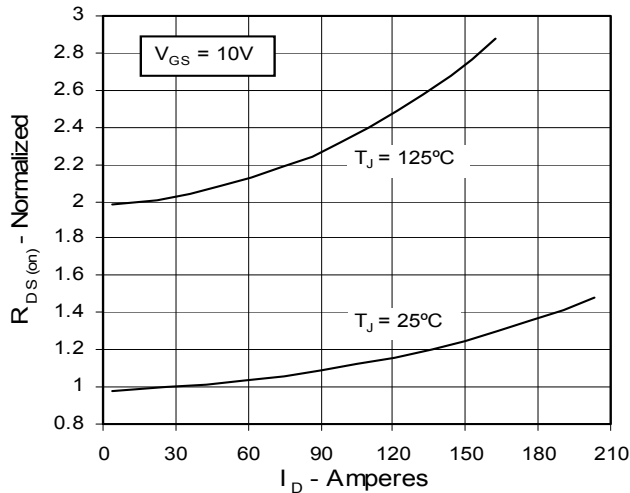

**Fig. 6. Drain Current vs. Case
Temperature**

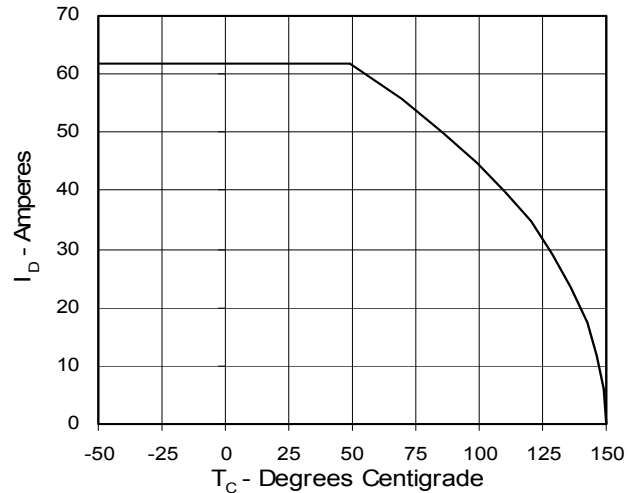

Fig. 7. Input Admittance

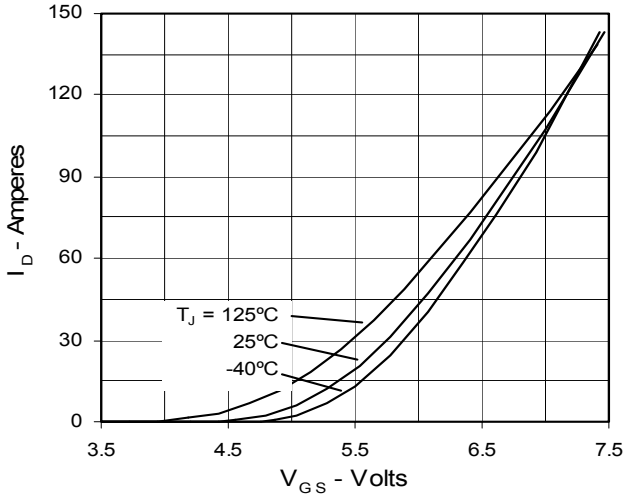

Fig. 8. Transconductance

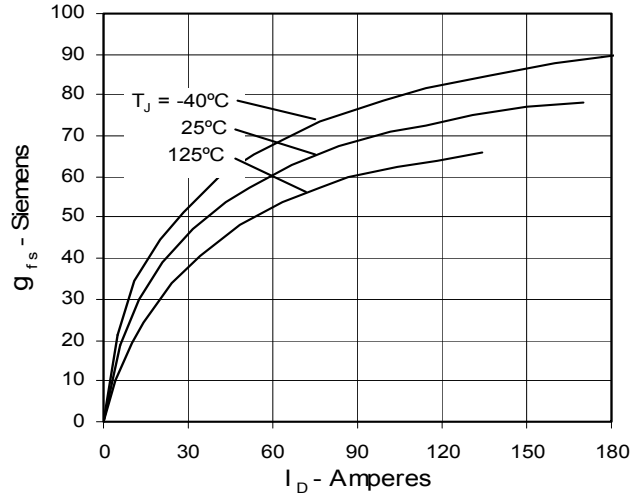

Fig. 9. Source Current vs. Source-To-Drain Voltage

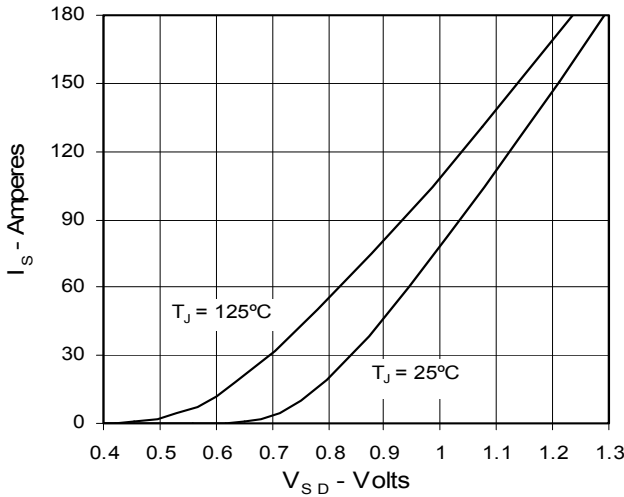

Fig. 10. Gate Charge

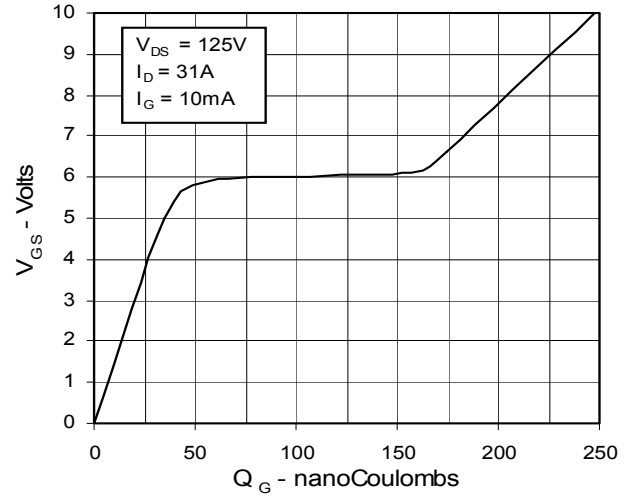

Fig. 11. Capacitance

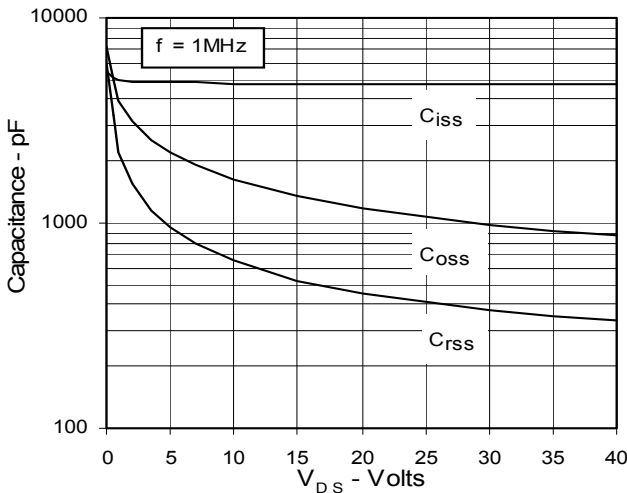
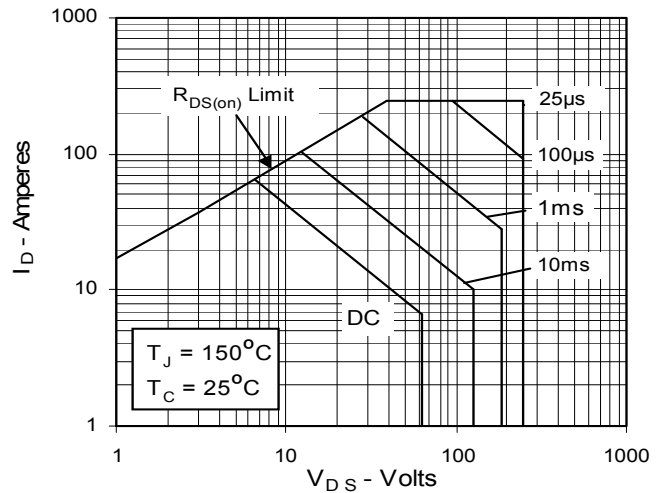

Fig. 12. Forward-Bias Safe Operating Area



IXYS reserves the right to change limits, test conditions, and dimensions.

IXYS MOSFETs and IGBTs are covered by one or more of the following U.S. patents:

4,835,592	4,881,106	5,017,508	5,049,961	5,187,117	5,381,025	6,162,665	6,306,728 B1	6,534,343	6,683,344
4,850,072	4,931,844	5,034,796	5,063,307	5,237,481	5,486,715	6,259,123 B1	6,404,065 B1	6,583,505	6,710,405 B2

Fig. 13. Maximum Transient Thermal Resistance

