

# HiPerFET™

## Power MOSFETs

### Q-Class

IXFH 60N25Q  
IXFK 60N25Q  
IXFT 60N25Q

$$V_{DSS} = 250 \text{ V}$$

$$I_{D25} = 60 \text{ A}$$

$$R_{DS(on)} = 47 \text{ m}\Omega$$

$$t_{rr} \leq 250 \text{ ns}$$

N-Channel Enhancement Mode  
Avalanche Rated, High  $dv/dt$ , Low  $t_{rr}$   
Low Gate Charge and Capacitances

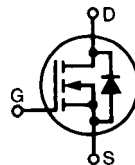

Symbol	Test Conditions	Maximum Ratings	
$V_{DSS}$	$T_J = 25^\circ\text{C}$ to $150^\circ\text{C}$	250	V
$V_{DGR}$	$T_J = 25^\circ\text{C}$ to $150^\circ\text{C}$ ; $R_{GS} = 1 \text{ M}\Omega$	250	V
$V_{GS}$	Continuous	$\pm 20$	V
$V_{GSM}$	Transient	$\pm 30$	V
$I_{D25}$	$T_C = 25^\circ\text{C}$	60	A
$I_{DM}$	$T_C = 25^\circ\text{C}$ , pulse width limited by $T_{JM}$	240	A
$I_{AR}$	$T_C = 25^\circ\text{C}$	60	A
$E_{AR}$	$T_C = 25^\circ\text{C}$	45	mJ
$E_{AS}$	$T_C = 25^\circ\text{C}$	1.5	J
$dv/dt$	$I_S \leq I_{DM}$ , $di/dt \leq 100 \text{ A}/\mu\text{s}$ , $V_{DD} \leq V_{DSS}$ , $T_J \leq 150^\circ\text{C}$ , $R_G = 2 \Omega$	5	V/ns
$P_D$	$T_C = 25^\circ\text{C}$	360	W
$T_J$		-55 ... +150	$^\circ\text{C}$
$T_{JM}$		150	$^\circ\text{C}$
$T_{stg}$		-55 ... +150	$^\circ\text{C}$
$T_L$	1.6 mm (0.063 in) from case for 10 s	300	$^\circ\text{C}$
$M_d$	Mounting torque	TO-247 TO-264	1.13/10 Nm/lb.in. 0.9/6 Nm/lb.in.
Weight		TO-247	6 g
		TO-264	10 g
		TO-268	4 g

TO-247 AD (IXFH)

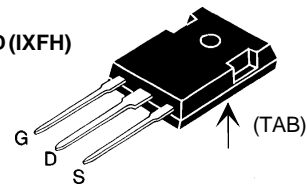

TO-268 (D3) (IXFT)

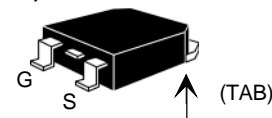

TO-264 AA (IXFK)

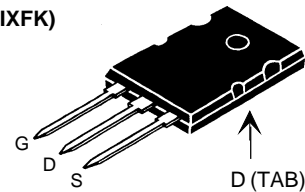

G = Gate  
S = Source

TAB = Drain

### Features

- Low gate charge
- International standard packages
- Epoxy meet UL94 V-0, flammability classification
- Low  $R_{DS(on)}$  HDMOS™ process
- Rugged polysilicon gate cell structure
- Avalanche energy and current rated
- Fast intrinsic Rectifier

### Advantages

- Easy to mount
- Space savings
- High power density

Symbol	Test Conditions	Characteristic Values ( $T_J = 25^\circ\text{C}$ , unless otherwise specified)		
		min.	typ.	max.
$V_{DSS}$	$V_{GS} = 0 \text{ V}$ , $I_D = 1 \text{ mA}$	250		V
$V_{GS(th)}$	$V_{DS} = V_{GS}$ , $I_D = 4 \text{ mA}$	2		V
$I_{GSS}$	$V_{GS} = \pm 20 \text{ V}_{DC}$ , $V_{DS} = 0$			$\pm 200 \text{ nA}$
$I_{DSS}$	$V_{DS} = V_{DSS}$ $V_{GS} = 0 \text{ V}$	$T_J = 25^\circ\text{C}$		50 $\mu\text{A}$
		$T_J = 125^\circ\text{C}$		1 mA
$R_{DS(on)}$	$V_{GS} = 10 \text{ V}$ , $I_D = 0.5 \cdot I_{D25}$ Pulse test, $t \leq 300 \mu\text{s}$ , duty cycle $d \leq 2\%$			47 m $\Omega$

Symbol	Test Conditions	Characteristic Values ( $T_J = 25^\circ\text{C}$ , unless otherwise specified)		
		min.	typ.	max.
$g_{fs}$	$V_{DS} = 10\text{ V}; I_D = 0.5 \cdot I_{D25}$ , pulse test	22	35	S
$C_{iss}$	$V_{GS} = 0\text{ V}, V_{DS} = 25\text{ V}, f = 1\text{ MHz}$		5100	pF
$C_{oss}$			1000	pF
$C_{rss}$			400	pF
$t_{d(on)}$	$V_{GS} = 10\text{ V}, V_{DS} = 0.5 \cdot V_{DSS}, I_D = 0.5 \cdot I_{D25}$ $R_G = 2.0\ \Omega$ (External),		27	ns
$t_r$			60	ns
$t_{d(off)}$			80	ns
$t_f$			25	ns
$Q_{g(on)}$	$V_{GS} = 10\text{ V}, V_{DS} = 0.5 \cdot V_{DSS}, I_D = 0.5 \cdot I_{D25}$		180	nC
$Q_{gs}$			39	nC
$Q_{gd}$			90	nC
$R_{thJC}$			0.35	K/W
$R_{thCK}$	TO-247		0.25	K/W
	TO-264		0.15	K/W

### Source-Drain Diode

Symbol	Test Conditions	Characteristic Values ( $T_J = 25^\circ\text{C}$ , unless otherwise specified)		
		min.	typ.	max.
$I_S$	$V_{GS} = 0\text{ V}$			60 A
$I_{SM}$	Repetitive; pulse width limited by $T_{JM}$			240 A
$V_{SD}$	$I_F = I_S, V_{GS} = 0\text{ V}$ , Pulse test, $t \leq 300\ \mu\text{s}$ , duty cycle $d \leq 2\%$			1.5 V
$t_{rr}$	$I_F = I_S - di/dt = 100\text{ A}/\mu\text{s}, V_R = 100\text{ V}$		1	250 ns
$Q_{RM}$			8	$\mu\text{C}$
$I_{RM}$				A

### TO-268AA (IXFT) (D<sup>3</sup> PAK)

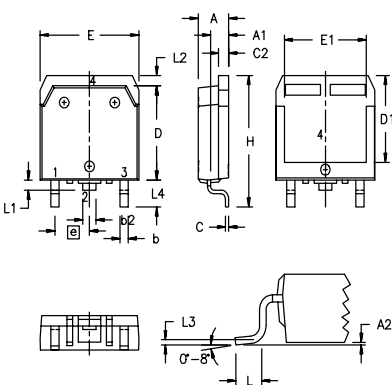

Dim.	Millimeter		Inches	
	Min.	Max.	Min.	Max.
A	4.9	5.1	.193	.201
A <sub>1</sub>	2.7	2.9	.106	.114
A <sub>2</sub>	.02	.25	.001	.010
b	1.15	1.45	.045	.057
b <sub>2</sub>	1.9	2.1	.75	.83
C	.4	.65	.016	.026
D	13.80	14.00	.543	.551
E	15.85	16.05	.624	.632
E <sub>1</sub>	13.3	13.6	.524	.535
e	5.45 BSC		.215 BSC	
H	18.70	19.10	.736	.752
L	2.40	2.70	.094	.106
L1	1.20	1.40	.047	.055
L2	1.00	1.15	.039	.045
L3	0.25 BSC		.010 BSC	
L4	3.80	4.10	.150	.161

### TO-247 AD (IXFH) Outline

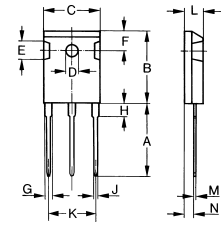

Dim.	Millimeter		Inches	
	Min.	Max.	Min.	Max.
A	19.81	20.32	0.780	0.800
B	20.80	21.46	0.819	0.845
C	15.75	16.26	0.610	0.640
D	3.55	3.65	0.140	0.144
E	4.32	5.49	0.170	0.216
F	5.4	6.2	0.212	0.244
G	1.65	2.13	0.065	0.084
H	-	4.5	-	0.177
J	1.0	1.4	0.040	0.055
K	10.8	11.0	0.426	0.433
L	4.7	5.3	0.185	0.209
M	0.4	0.8	0.016	0.031
N	1.5	2.49	0.087	0.102

### TO-264 AA (IXFK) Outline

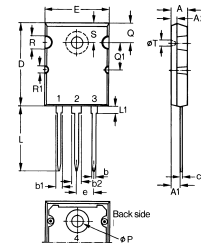

Dim.	Millimeter		Inches	
	Min.	Max.	Min.	Max.
A	4.82	5.13	.190	.202
A <sub>1</sub>	2.54	2.89	.100	.114
A <sub>2</sub>	2.00	2.10	.079	.083
b	1.12	1.42	.044	.056
b <sub>1</sub>	2.39	2.69	.094	.106
b <sub>2</sub>	2.90	3.09	.114	.122
c	0.53	0.83	.021	.033
D	25.91	26.16	1.020	1.030
E	19.81	19.96	.780	.786
e	5.46 BSC		.215 BSC	
J	0.00	0.25	.000	.010
K	0.00	0.25	.000	.010
L	20.32	20.83	.800	.820
L <sub>1</sub>	2.29	2.59	.090	.102
P	3.17	3.66	.125	.144
Q	6.07	6.27	.239	.247
Q <sub>1</sub>	8.38	8.69	.330	.342
R	3.81	4.32	.150	.170
R <sub>1</sub>	1.78	2.29	.070	.090
S	6.04	6.30	.238	.248
T	1.57	1.83	.062	.072

### Min. Recommended Footprint

