

1 2 3 4 5 6 7 8

A B C D E F

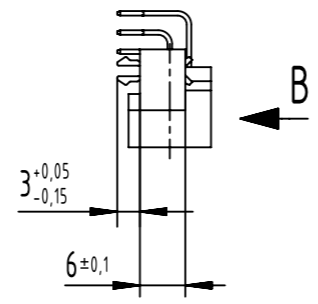

A-A (2:1)

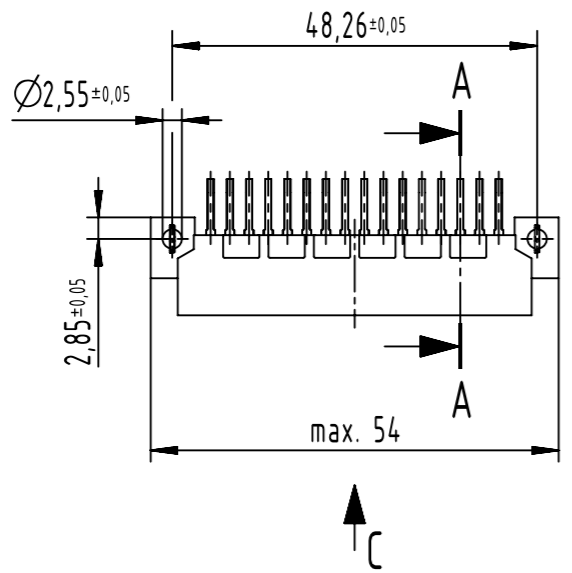
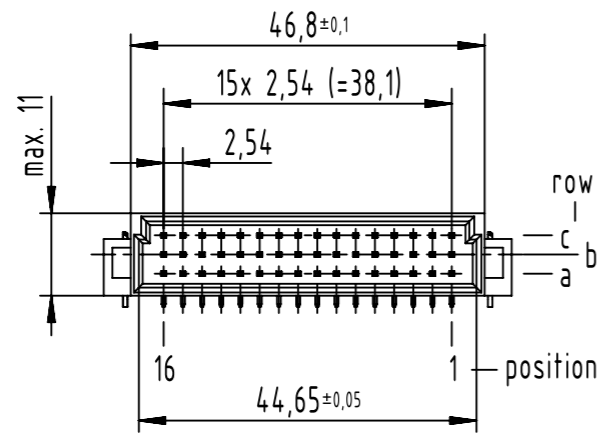
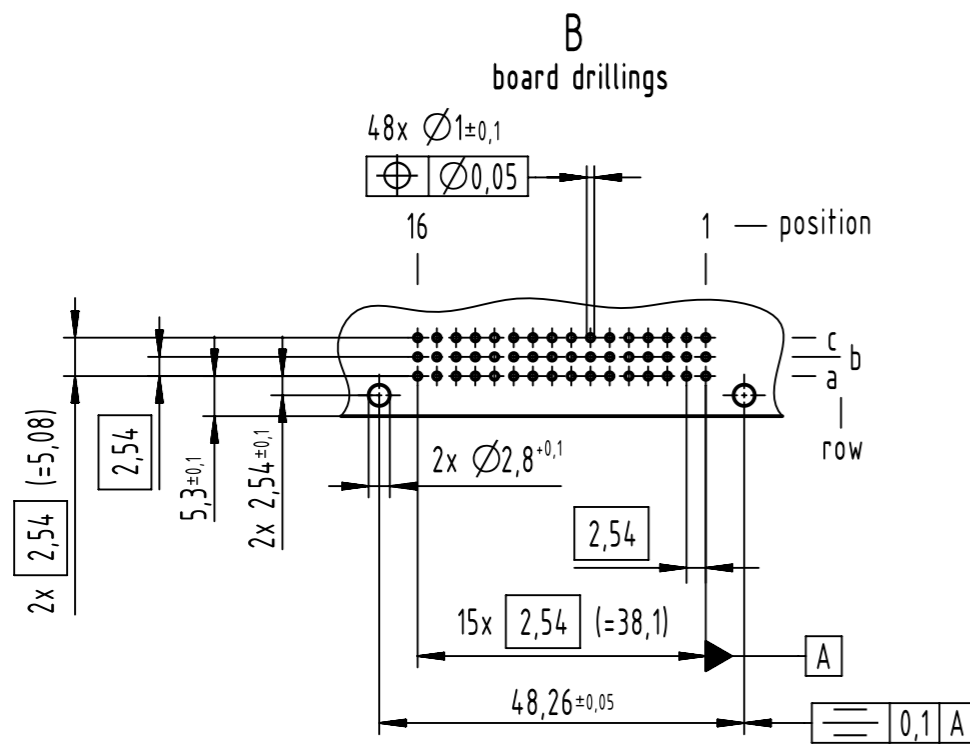
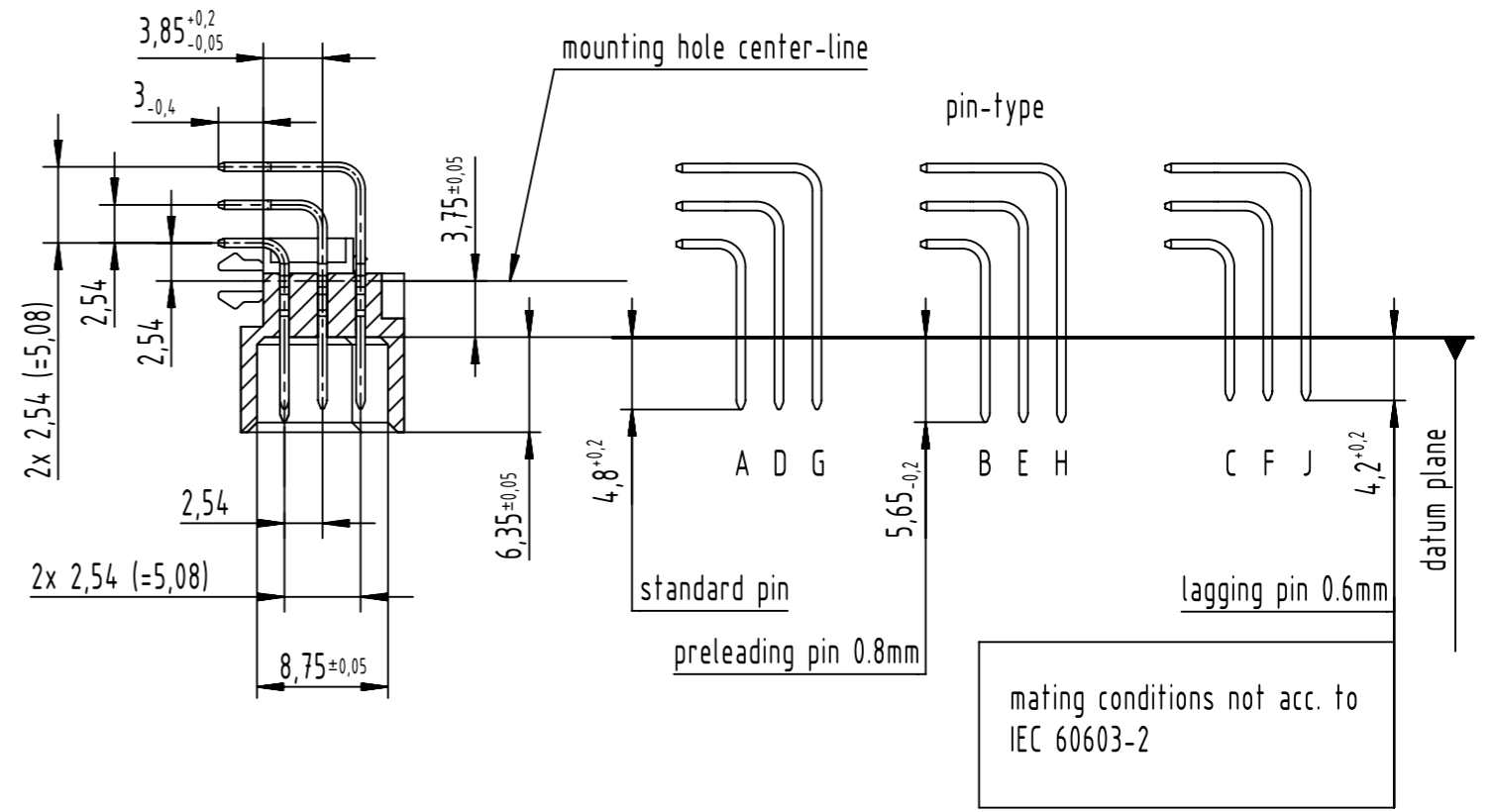

mating conditions not acc. to IEC 60603-2

contact loading

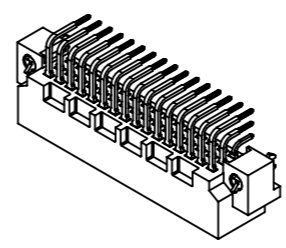
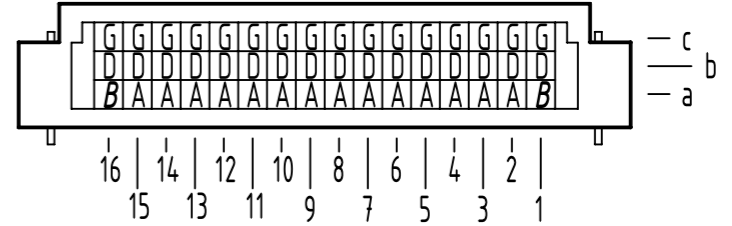

further information see product data sheet

09 23 348 6951	2
part no.	performance level

<p>All rights reserved Department EL PD</p>	<p>All Dimensions in mm Original Size DIN A3</p>		<p>Scale 1:1</p>	<p>Free size tol. IEC 60603-2</p>	<p>Ref. Sub.</p>
	<p>Created by STORCK</p>	<p>Inspected by LEHNERT</p>	<p>Standardisation</p>	<p>Date 2021-11-05</p>	<p>State Final Release</p>
<p>HARTING D-32339 Espelkamp</p>	<p>Title DIN Signal type 2C male solder angled clip 48-pole</p>				<p>Doc-Key / ECM-Nr. 100072926/UGD/116/C 50000204801</p>
	<p>Type TB</p>	<p>Number 0923348X951</p>			<p>Rev. C</p>
					<p>Page 1/1</p>

1 2 3 4 5 6 7 8