

NTC Thermistor : TTC3 Series



Φ3 mm Lead Type for Temperature Sensing/Compensation

■ Features

1. RoHS compliant
2. Halogen-Free(HF) series are available
3. Body size: Φ3mm
4. Radial lead resin coated
5. Operating temperature range: -40°C~+125°C
6. Wide resistance range
7. Cost effective
8. Agency recognition: UL / cUL / TUV / CQC

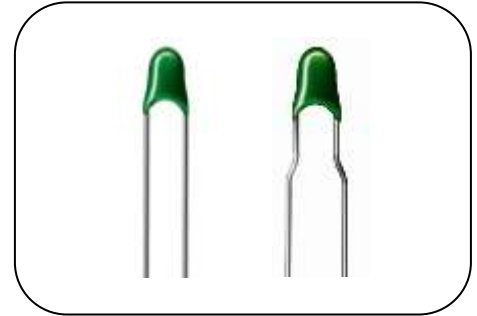

■ Recommended Applications

1. Home appliances
2. Computers
3. Digital meters
4. Switch mode power supplies
5. Adapters

■ Part Number Code

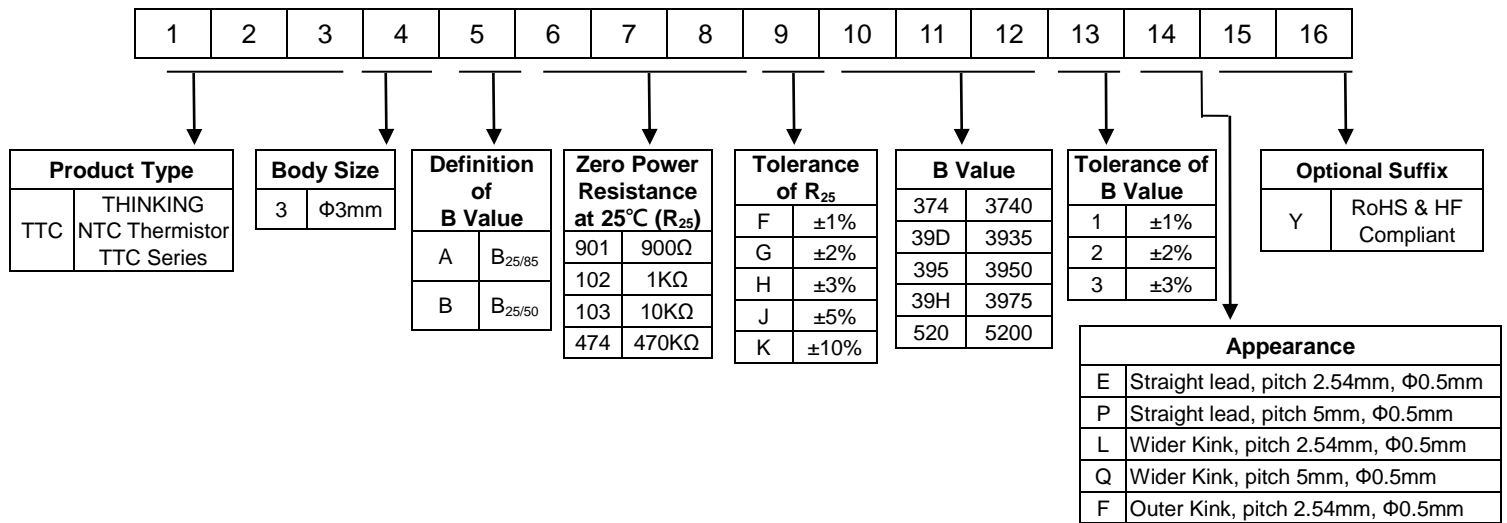

NTC Thermistor : TTC3 Series



Φ3 mm Lead Type for Temperature Sensing/Compensation

■ Structure and Dimensions

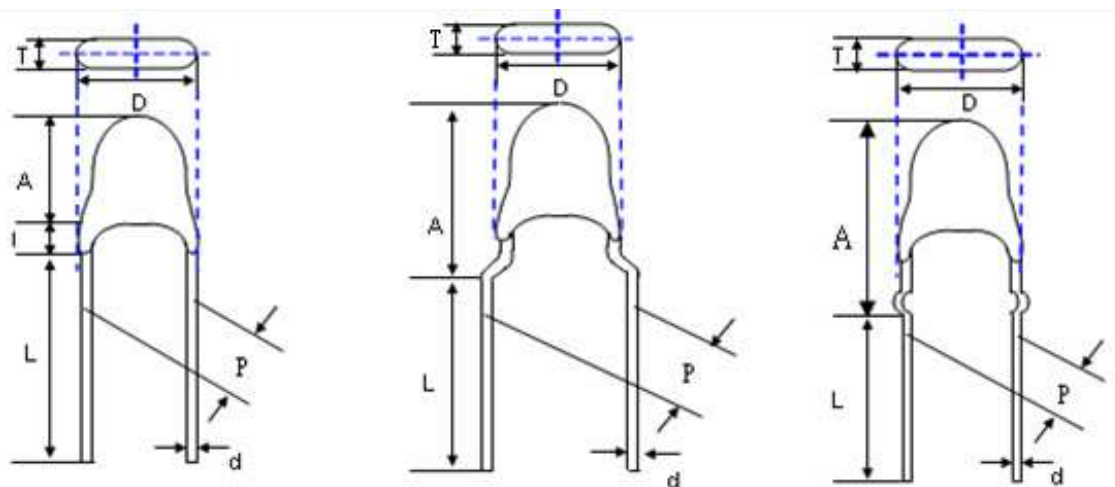

Straight Lead

Wider Kink

Outer Kink

(Unit: mm)

Lead Type	Pitch	D	d	P	A	I _{max.}	L	T
Straight Lead	2.54	2.5~4	0.48~0.52	2.04~3.04	2.5~5	3	30~40	1.5~3
	5	2~6.5		4.5~5.5	7 (max)	3	30~40	1.5~5
Wider Kink	2.54	2~4		2.04~3.04	6 (max)	--	30~40	1.5~3
	5	2~4		4.5~5.5	10 (max)	--	30~40	1.5~3
Outer Kink	2.54	2~4		2.04~3.04	13.5 (max)	--	24.5~34.5	1.5~3

Note*:

Caution: It has be better to keep the minimum distance as 6mm between the bottom of the thermistor body and PCB surface to prevent component damage.

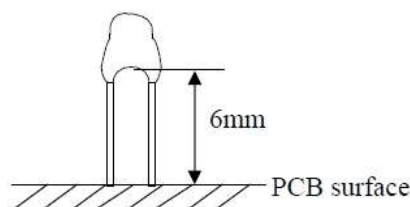

NTC Thermistor : TTC3 Series



Φ3 mm Lead Type for Temperature Sensing/Compensation

Electrical Characteristics

Part No.	Zero Power Resistance at 25°C	Tolerance of R ₂₅ (±%)	B Value (K)	Tolerance of B value (±%)	Max. Power Dissipation at 25°C P _{max} (mW)	Dissipation Factor δ(mW/°C)	Thermal Time Constant τ (Sec.)	Operating Temperature Range T _L ~T _U (°C)	Safety Approvals		
	R ₂₅ (KΩ)								UL cUL	TUV	CQC
TTC3A901□39D*	0.9	1, 2, 3, 5	25/85	2, 3	150	≥ 2.5	≤ 18	-40~+125	√	√	√
TTC3A102□39D*	1								√	√	√
TTC3A152□39D*	1.5								√	√	√
TTC3A202□39H*	2								√	√	√
TTC3A222□39H*	2.2								√	√	√
TTC3A272□39H*	2.7								√	√	√
TTC3A302□39H*	3								√	√	√
TTC3A332□39H*	3.3								√	√	√
TTC3A472□39H*	4.7								√	√	√
TTC3A482□395*	4.8								√	√	
TTC3A482□39H*	4.8								√	√	
TTC3A502□39H*	5								√	√	√
TTC3A682□39H*	6.8								√	√	√
TTC3A103□34D*	10								√	√	√
TTC3A103□374*	10		√	√					√		
TTC3A103□39H*	10		√	√					√		
TTC3A123□374*	12		√	√					√		
TTC3A153□374*	15		√	√					√		
TTC3A203□374*	20		√	√					√		
TTC3A203□426*	20		√	√					√		
TTC3A223□374*	22		√	√					√		
TTC3A333□409*	33		√	√					√		
TTC3A473□409*	47		√	√					√		
TTC3A503□39H*	50		√	√					√		
TTC3A503□406*	50		√	√					√		
TTC3A683□419*	68		√	√					√		
TTC3A104□419*	100		√	√					√		
TTC3A104□436*	100		√	√					√		
TTC3A154□437*	150	√	√	√							
TTC3A204□385*	200	√	√								
TTC3A224□437*	220	√	√	√							
TTC3A334□457*	330	√	√	√							
TTC3A474□457*	470	√	√	√							
TTC3A474□520*	470	√	√	√							
TTC3B202□350*	2	25/50	3500	2, 3	√	√	√				
TTC3B473□39D*	47		3935	1, 2, 3	√	√	√				
TTC3B503□440*	50		4400	2, 3	√	√	√				
TTC3B434□507*	430		5070		√	√					
TTC3B474□520*	470		5200	3	√	√	√				

Note 1: □ = Tolerance of R₂₅

* = Tolerance of B value

Note 2: UL/cUL File No: E138827, TUV File No: R50050155

CQC File No: CQC04001011945, CQC04001011966

Note 3: Special specifications are available upon request.

NTC Thermistor : TTC3 Series



Φ3 mm Lead Type for Temperature Sensing/Compensation

Max. Power Dissipation Derating Curve

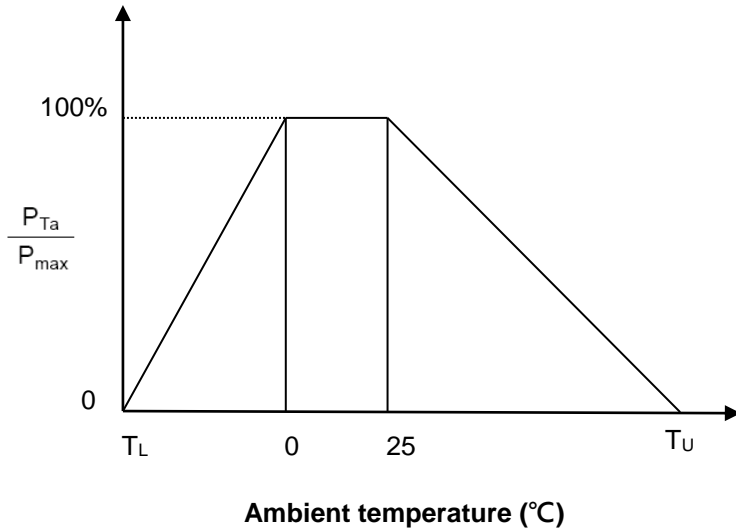

T_U : Maximum operating temperature (°C)

T_L : Minimum operating temperature (°C)

For example:

Ambient temperature(T_a) = 55°C

Maximum operating temperature(T_U) = 125°C

$$P_{Ta} = (T_U - T_a) / (T_U - 25) \times P_{max} = 70\% P_{max}$$

R-T Characteristic Curves

TTC3A901□39D*~ TTC3A474□520*

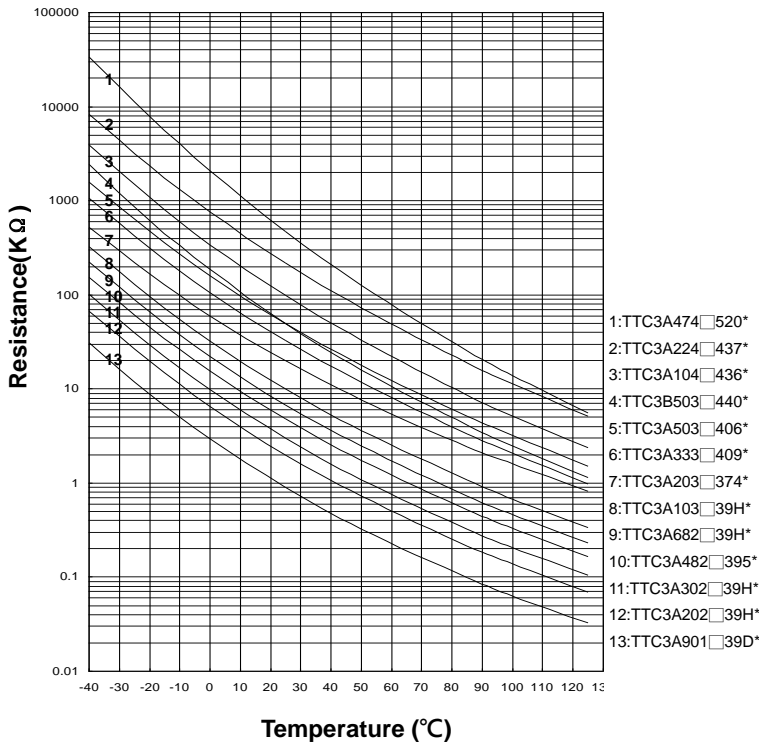

TTC3A102□39D*~ TTC3B434□507*

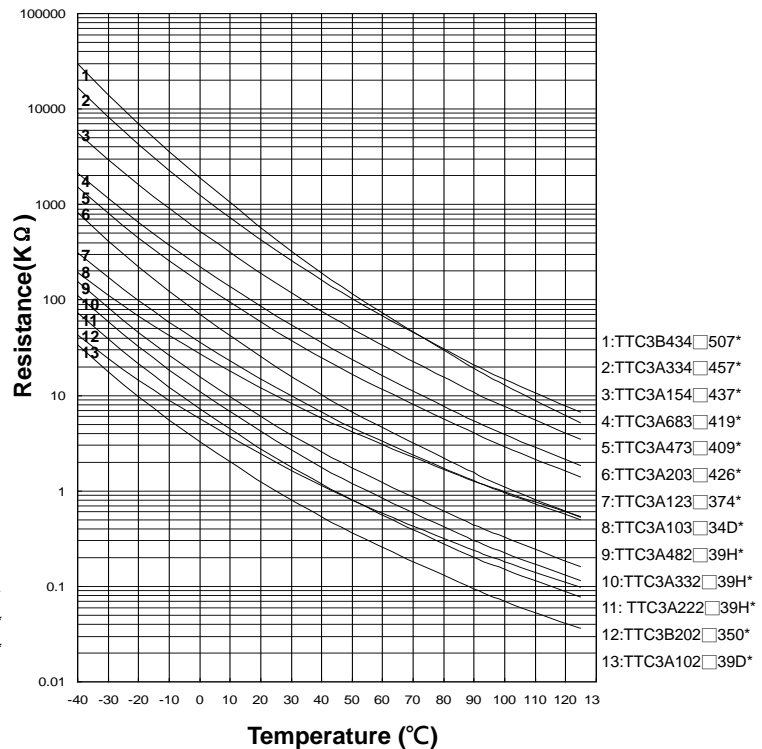

NTC Thermistor : TTC3 Series



Φ3 mm Lead Type for Temperature Sensing/Compensation

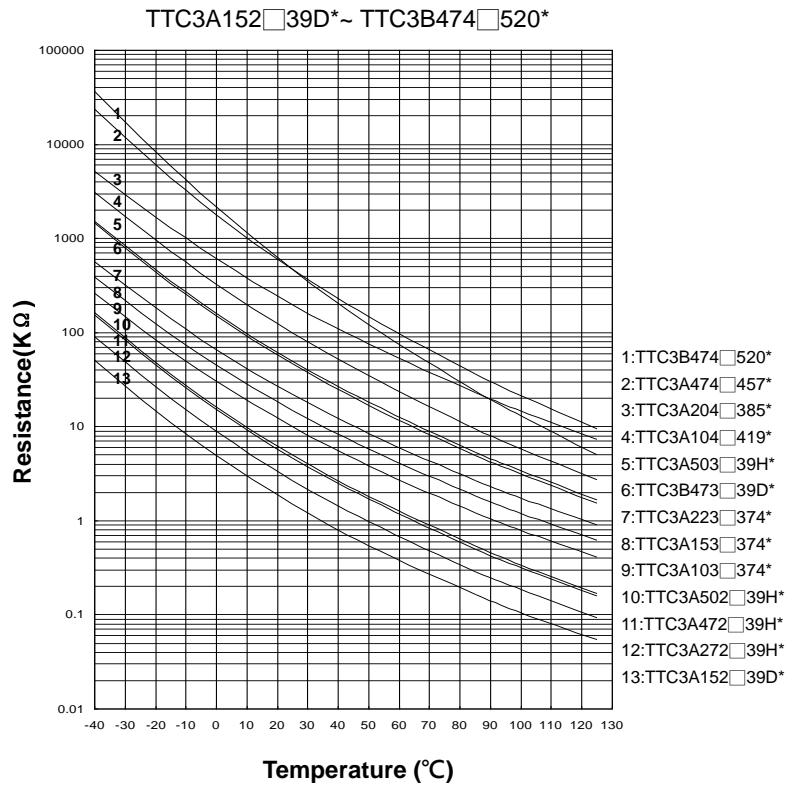

■ Soldering Recommendation

● Wave Soldering Profile

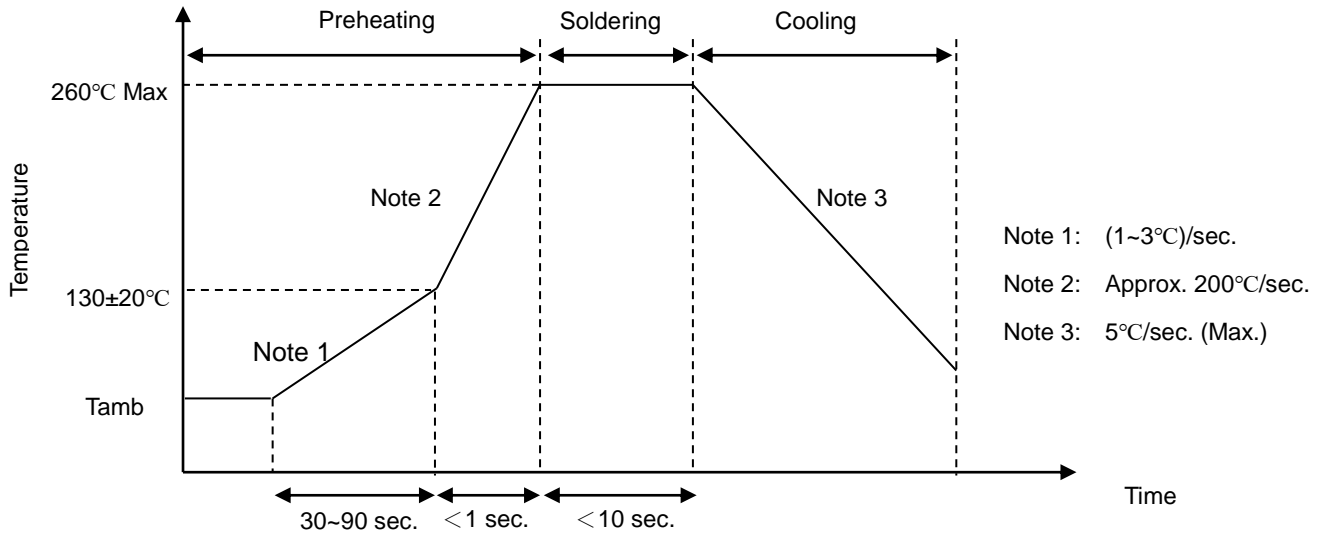

● Recommended Reworking Conditions with Soldering Iron

Item	Conditions
Temperature of Soldering Iron-tip	360°C (max.)
Soldering Time	3 sec. (max.)
Distance from Thermistor	2 mm (min.)

NTC Thermistor : TTC3 Series



Φ3 mm Lead Type for Temperature Sensing/Compensation

■ Reliability

Item	Standard	Test conditions / Methods	Specifications															
Tensile Strength of Terminations	IEC 60068-2-21	<p>Gradually apply the specified force and keep the unit fixed for 10±1 sec.</p> <table border="0"> <tr> <td style="text-align: center;">Terminal diameter (mm)</td> <td style="text-align: center;">Force (Kg)</td> </tr> <tr> <td style="text-align: center;">0.3<d≤ 0.5</td> <td style="text-align: center;">0.5</td> </tr> </table>	Terminal diameter (mm)	Force (Kg)	0.3<d≤ 0.5	0.5	No visible damage											
Terminal diameter (mm)	Force (Kg)																	
0.3<d≤ 0.5	0.5																	
Bending Strength of Terminations	IEC 60068-2-21	<p>Hold specimen and apply the force specified below to each lead. Bend the specimen to 90°, and then return to the original position. Repeat the procedure in the opposite direction.</p> <table border="0"> <tr> <td style="text-align: center;">Terminal diameter (mm)</td> <td style="text-align: center;">Force (Kg)</td> </tr> <tr> <td style="text-align: center;">0.3<d≤ 0.5</td> <td style="text-align: center;">0.25</td> </tr> </table>	Terminal diameter (mm)	Force (Kg)	0.3<d≤ 0.5	0.25	No visible damage											
Terminal diameter (mm)	Force (Kg)																	
0.3<d≤ 0.5	0.25																	
Solderability	IEC 60068-2-20	245±3 °C, 3±0.3 sec.	At least 95% of terminal electrode is covered by new solder															
Resistance to Soldering Heat	IEC 60068-2-20	260 ± 3°C, 10 ± 1 sec.	No visible damage Δ R ₂₅ /R ₂₅ ≤ 3 %															
High Temperature Storage	IEC 60068-2-2	125 ± 5°C , 1000 ± 24 hrs	No visible damage Δ R ₂₅ /R ₂₅ ≤ 5 %															
Damp Heat, Steady State	IEC 60068-2-78	40 ± 2°C , 90~95% RH , 1000 ± 24 hrs	No visible damage Δ R ₂₅ /R ₂₅ ≤ 3 %															
Rapid Change of Temperature	IEC 60068-2-14	<p>The conditions shown below shall be repeated 5 cycles</p> <table border="1"> <thead> <tr> <th>Step</th> <th>Temperature (°C)</th> <th>Period (minutes)</th> </tr> </thead> <tbody> <tr> <td>1</td> <td>-40 ± 5</td> <td>30 ± 3</td> </tr> <tr> <td>2</td> <td>Room temperature</td> <td>5 ± 3</td> </tr> <tr> <td>3</td> <td>125 ± 5</td> <td>30 ± 3</td> </tr> <tr> <td>4</td> <td>Room temperature</td> <td>5 ± 3</td> </tr> </tbody> </table>	Step	Temperature (°C)	Period (minutes)	1	-40 ± 5	30 ± 3	2	Room temperature	5 ± 3	3	125 ± 5	30 ± 3	4	Room temperature	5 ± 3	No visible damage Δ R ₂₅ /R ₂₅ ≤ 3 %
Step	Temperature (°C)	Period (minutes)																
1	-40 ± 5	30 ± 3																
2	Room temperature	5 ± 3																
3	125 ± 5	30 ± 3																
4	Room temperature	5 ± 3																
Max. Power Dissipation	IEC 60539-1 4.26.3	25 ± 5°C, Pmax. , 1000 ± 24 hrs	No visible damage Δ R ₂₅ /R ₂₅ ≤ 5 %															

NTC Thermistor : TTC3 Series



Φ3 mm Lead Type for Temperature Sensing/Compensation

■ Packaging

● Taping Specification

Straight Lead

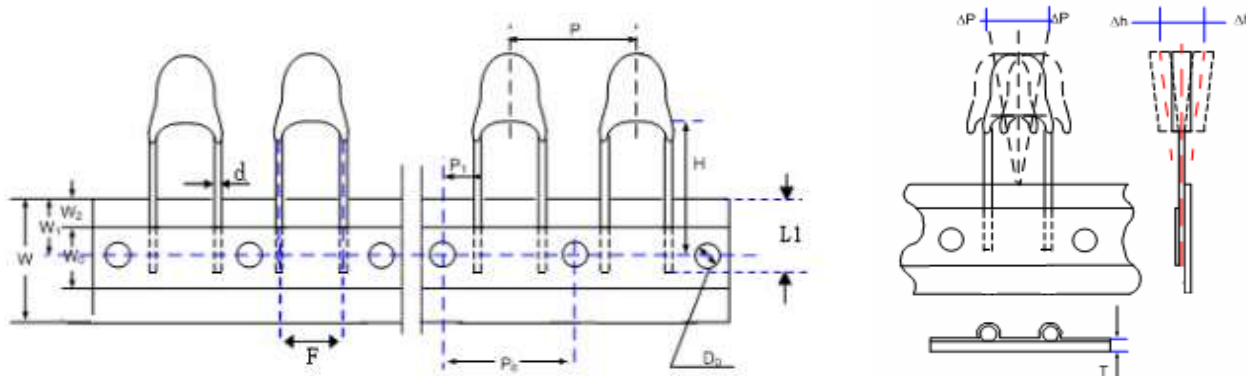

(Unit: mm)

Taping Dimension	P ₀	F	P	P ₁	H	d	W ₀	W ₁	W ₂	W	ΔP	Δh	L ₁	D ₀	T
	±0.3	±0.5	±1	±0.7	+2/-0	±0.02	±1.5	+0.75 /-0.5	Max.	+1/ -0.5	Max.	Max.	±1	±0.2	±0.2
P ₀ =12.7	12.7	2.54	12.7	5.08	18	0.5	12	9	3	18	1	2	10	4	0.6
	12.7	5	12.7	3.85	18	0.5	12	9	3	18	1	2	10	4	0.6
P ₀ =15.0	15	2.54	15	6.23	18	0.5	12	9	3	18	1	2	10	4	0.6
	15	5	15	5	18	0.5	12	9	3	18	1	2	10	4	0.6

Wider Kink

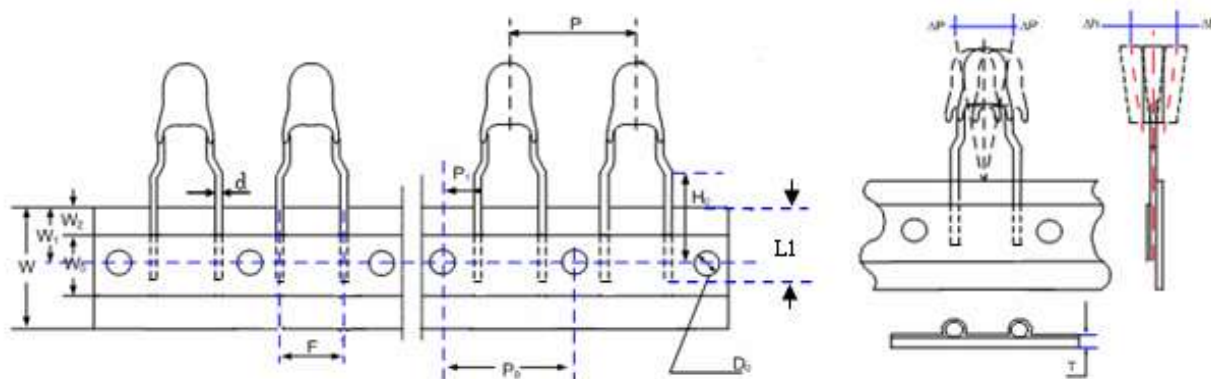

(Unit: mm)

Taping Dimension	P ₀	F	P	P ₁	H ₀	d	W ₀	W ₁	W ₂	W	ΔP	Δh	L ₁	D ₀	T
	±0.3	±0.5	±1	±0.7	±0.5	±0.02	±1.5	+0.75 /-0.5	Max.	+1/ -0.5	Max.	Max.	±1	±0.2	±0.2
P ₀ =12.7	12.7	2.54	12.7	5.08	16	0.5	12	9	3	18	1	2	10	4	0.6
	12.7	5.00	12.7	3.85	16	0.5	12	9	3	18	1	2	10	4	0.6

NTC Thermistor : TTC3 Series



Φ3 mm Lead Type for Temperature Sensing/Compensation

Outer Kink

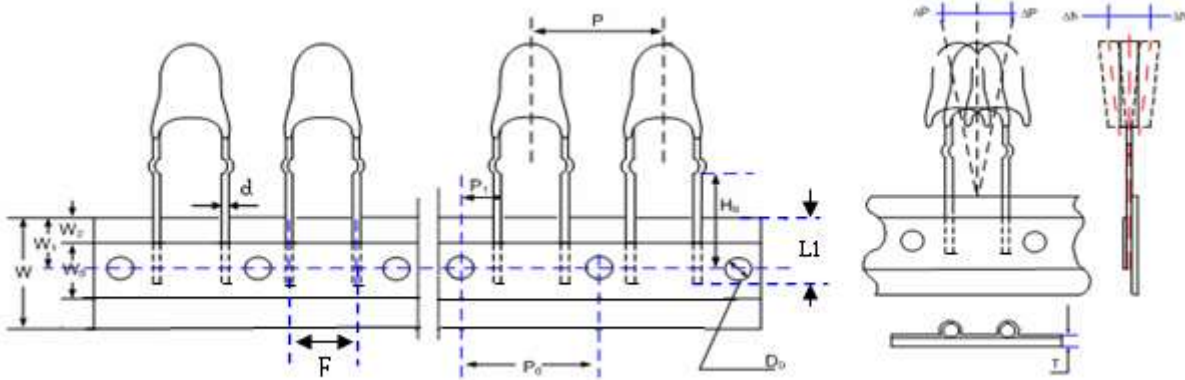

(Unit: mm)

Taping Dimension	P ₀	F	P	P ₁	H ₀	d	W ₀	W ₁	W ₂	W	ΔP	Δh	L ₁	D ₀	T
	±0.3	±0.5	±1	±0.7	±0.5	±0.02	±1.5	+0.75 /-0.5	Max.	+1/ -0.5	Max.	Max.	±1	±0.2	±0.2
P ₀ =12.7	12.7	2.54	12.7	5.08	16	0.5	12	9	3	18	1	2	10	4	0.6

Quantity

● Bulk Packing

Series	Quantity (pcs/bag)
TTC3	500

● Reel Packing

Series	Quantity (pcs/reel)
TTC3	2,500

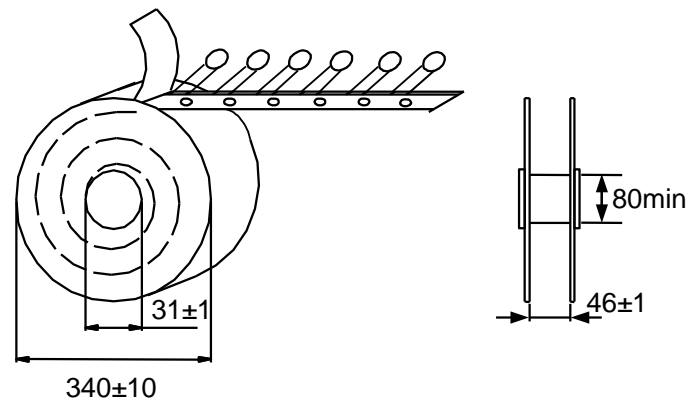

(Unit: mm)

● Ammo Packing

Series	Quantity (pcs/box)
TTC3	2,500

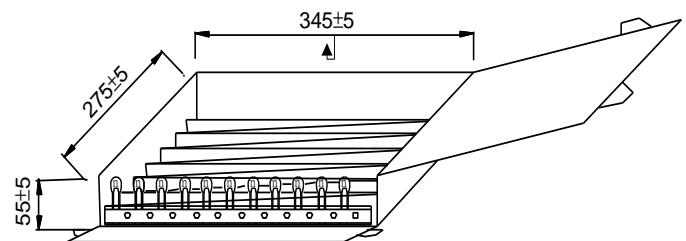

Warehouse Storage Conditions of Products

● Storage Conditions:

1. Storage Temperature: -10°C~+40°C
2. Relative Humidity: ≤ 75%RH
3. Keep away from corrosive atmosphere and sunlight.

● Period of Storage : 1 year