

Power Relay

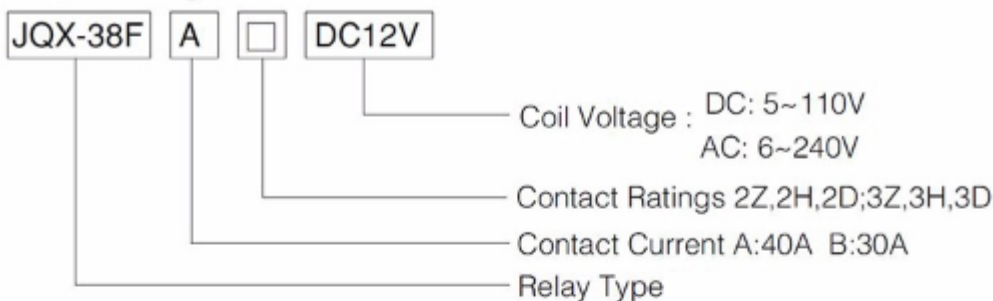

Contact Ratings	
Contact Ratings	2Z,2H,2D 3Z,3H,3D
Contact Resistance	100MΩ(1A 6VDC)
Contact Material	AgCdO
Contact Capacity	30A/40A 250VAC/30VDC 30A/40A 250VAC/30VDC
Specification	
Insulation Resistance	1000MΩ,500VDC
Dielectric Strength	BCC 2500V 1 min
	BOC 1200V 1 min
Operate Time	25ms/15ms
Terminal Type	PCB
Coil Ratings	
Normal Coil Power	DC2W~2.5W AC4.5VA

Coil Versions							
Nominal Voltage VDC	Pull-in Voltage VDC	Release Voltage VDC	Coil Resistance Ω:±10%	Nominal Voltage VAC	Pull-in Voltage VAC	Release Voltage VAC	Coil Resistance Ω:±10%
12	8.40	1.20	57	12	9.60	3.60	10
24	16.8	2.40	230	24	19.2	7.20	40.3
48	33.6	4.80	2000	110	88.0	36.00	847
60	42.0	6.00	2850	220/240	176.0	72.00	3380

JQX-38F

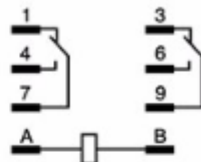
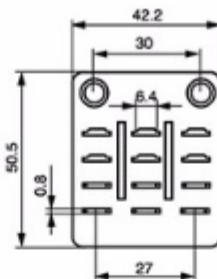
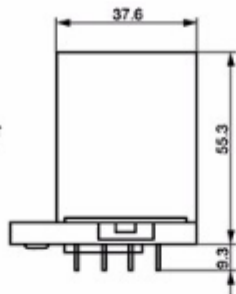

Dimension.Bottom View

JQX-38A

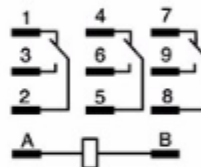
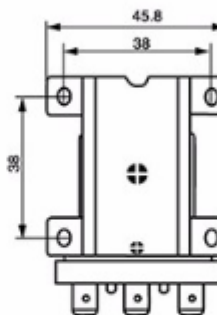
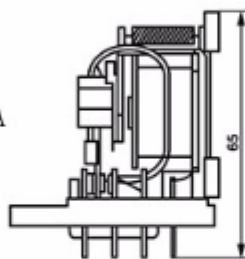

Reference Data

最大切换功率
Max.operating Power

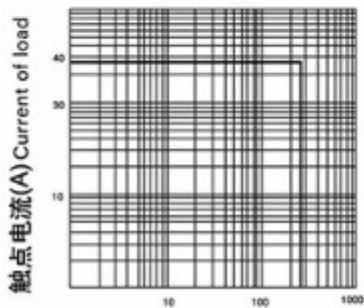

触点电压 Current Voltage (V)

电气寿命曲线
LIFE Expectancy

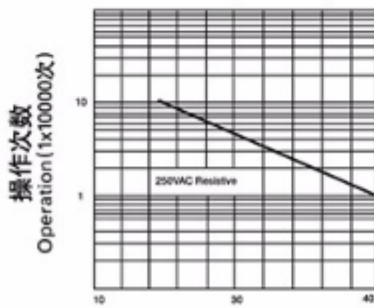

触点电流 Current of load (A)

线圈温升 Coil Temp.rise

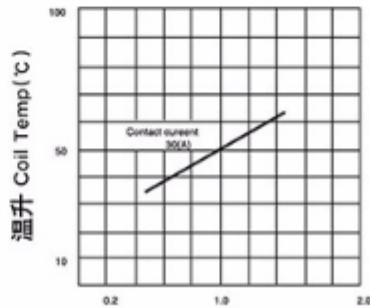

线圈额定电压百分比 Coil Voltage 100%