

1  
RoHS Compliance

Needle Bar

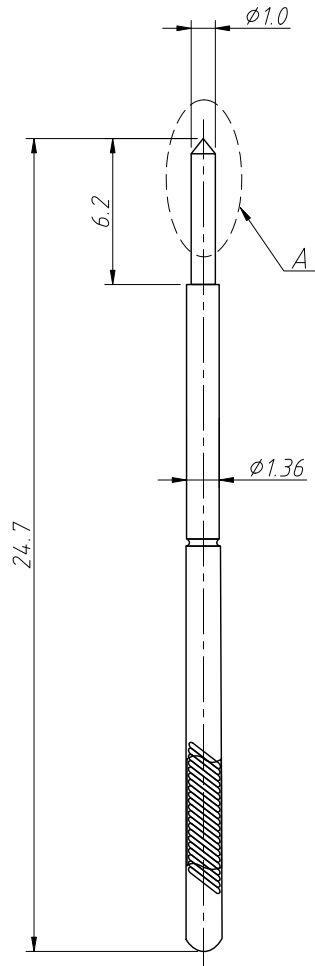

Bushing

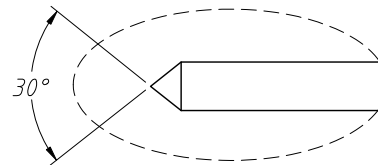
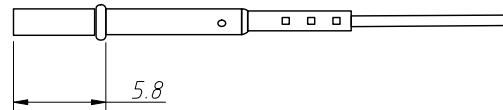
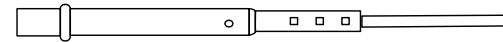
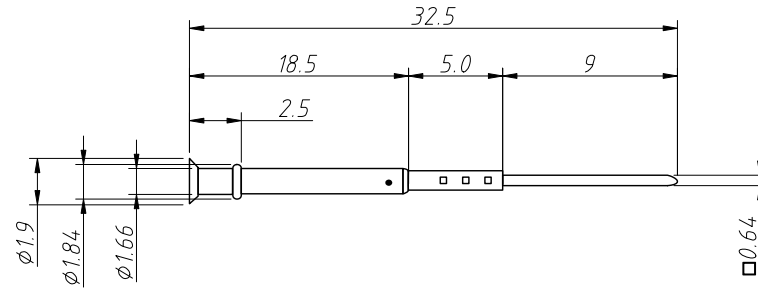

Detail A  
2:1

Notes:

1.Material:

Needle Bar:

Imported Material: Beryllium Copper Plated  
With Rhodium Or Gold

Domestic Material: Phosphor Bronze,  
Nickel Plated Or Gold Plated

Needle Tubing: Phosphor Bronze, Gold Plated

Bushing: Brass, Gold Plated

Spring: Stainless Steel

2.Electric:

Drill Size:  $\phi 1.70\text{mm}$

Rated Current: 3A

Rated Resistance:  $50\text{m}\Omega$

Compaction elasticity: 150g(180g)

Max Travel: 4.2mm

ANGLE TOLERANCE	PROJECTION	Description:	Probe Pin	
$\pm 3^\circ$				
GENERAL TOLERANCE	UNITS	mm	KLS P/N:	L-KLS1-P25-0126-G
x.x $\pm 0.30$	SHEET SIZE	A4	XX	NingBo KLS ELECTRONIC CO.,L TD.
x.xx $\pm 0.20$	Draw:	Daniel	2023-07-05	
x.xxx $\pm 0.10$	Check:	Daniel	2023-07-05	