

DCNHR Series

900V DC Max Contactor Relays

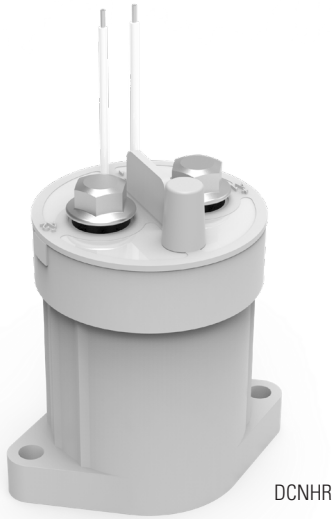

DCNHR

Description

The DCNHR Series 450V High-Current High-Voltage DC Contactor Relay is a normally open (also known as monostable) relay with a resin body for corrosion resistance in harsh automotive environments. Versions are available with a pulse width modulation (PWM) coil to reduce power for keeping the contacts closed. Sealed contacts help ensure there is no leakage of electrical arc for safety. The high-current relay's permanent magnets blow out the magnetic field horizontally to achieve a rapid extinguishing of the DC arc.

The DCNHR Series contactor relay is available for 20 A to 300 A contact switching as well as with and without polarized contacts to suit the polarity of your application.

Web Resources

Download 2D print, installation guide and technical resources at: littelfuse.com/DCNHR

Electrical Diagram

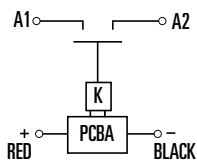

DCNHRXXXNFA

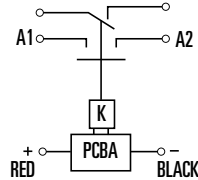

DCNHRXXXMFA

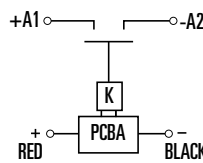

DCNHRXXXPFA

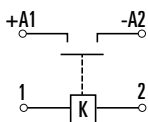

DCNHRXXXPFXX

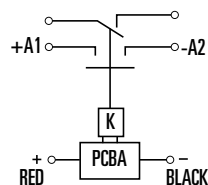

DCNHRXXXQFA

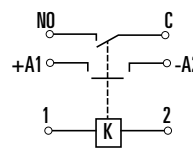

DCNHRXXXQFXX

Specifications

Max Voltage Rating (V DC):	900
Current Rating Continuous (A):	20-300
Coil Voltage Rating (V DC):	12, 24, 48, 9~36
Ingress Protection:	20-100: IP 67 150-300: Main contacts IP67 PWM circuit IP54
Operating Temperature (°C):	-40 to +85

Applications

- Battery electric vehicles
- Hybrid electric vehicles
- Electric maintenance vehicles
- Industrial applications

Features and Benefits

- Available with 20A to 300A contact switching capability
- Normally open relay design
- Resin housing provides corrosion resistance in harsh automotive environments
- Sealed contacts with no leakage of electrical arc for maximum safety
- Built-in energy-saving coil to reduce the coil holding power consumption
- RoHS compliant
- Available with mechanically linked auxiliary contacts

DCNHR Series

900V DC Max Contactor Relays

Ordering Information

PART NUMBER	CONTINUOUS CURRENT (A)	VOLTAGE RATING		MOUNTING	COIL VOLTAGE (V DC)	COIL TYPE	AUX CONTACT	POLARIZED	2D PRINT
		SYSTEM NOMINAL (V DC)	MAX VOLTAGE (V DC)						
DCNHR20PF12*	20	450	900	BOTTOM	12	Single	No	Yes	↓
DCNHR20PF24*	20	450	900	BOTTOM	24	Single	No	Yes	↓
DCNHR20PF48*	20	450	900	BOTTOM	48	Single	No	Yes	↓
DCNHR30PF12*	30	450	900	BOTTOM	12	Single	No	Yes	↓
DCNHR30PF24*	30	450	900	BOTTOM	24	Single	No	Yes	↓
DCNHR30PF48*	30	450	900	BOTTOM	48	Single	No	Yes	↓
DCNHR40PF12*	40	450	900	BOTTOM	12	Single	No	Yes	↓
DCNHR40PF24*	40	450	900	BOTTOM	24	Single	No	Yes	↓
DCNHR40PF48*	40	450	900	BOTTOM	48	Single	No	Yes	↓
DCNHR50PF12	50	450	900	BOTTOM	12	Single	No	Yes	↓
DCNHR50PF24	50	450	900	BOTTOM	24	Single	No	Yes	↓
DCNHR50PF48	50	450	900	BOTTOM	48	Single	No	Yes	↓
DCNHR50QF12	50	450	900	BOTTOM	12	Single	Yes	Yes	↓
DCNHR50QF24	50	450	900	BOTTOM	24	Single	Yes	Yes	↓
DCNHR50QF48	50	450	900	BOTTOM	48	Single	Yes	Yes	↓
DCNHR100PF12	100	450	900	BOTTOM	12	Single	No	Yes	↓
DCNHR100PF24	100	450	900	BOTTOM	24	Single	No	Yes	↓
DCNHR100PF48	100	450	900	BOTTOM	48	Single	No	Yes	↓
DCNHR100QF12	100	450	900	BOTTOM	12	Single	Yes	Yes	↓
DCNHR100QF24	100	450	900	BOTTOM	24	Single	Yes	Yes	↓
DCNHR100QF48	100	450	900	BOTTOM	48	Single	Yes	Yes	↓
DCNHR150MFA	150	450	900	BOTTOM	9-36	PWM	Yes	No	↓
DCNHR150NFA	150	450	900	BOTTOM	9-36	PWM	No	No	↓
DCNHR150PFA	150	450	900	BOTTOM	9-36	PWM	No	Yes	↓
DCNHR150QFA	150	450	900	BOTTOM	9-36	PWM	Yes	Yes	↓
DCNHR200MFA	200	450	900	BOTTOM	9-36	PWM	Yes	No	↓
DCNHR200NFA	200	450	900	BOTTOM	9-36	PWM	No	No	↓
DCNHR200PFA	200	450	900	BOTTOM	9-36	PWM	No	Yes	↓
DCNHR200QFA	200	450	900	BOTTOM	9-36	PWM	Yes	Yes	↓
DCNHR250MFA	250	450	900	BOTTOM	9-36	PWM	Yes	No	↓
DCNHR250NFA	250	450	900	BOTTOM	9-36	PWM	No	No	↓
DCNHR250PFA	250	450	900	BOTTOM	9-36	PWM	No	Yes	↓
DCNHR250QFA	250	450	900	BOTTOM	9-36	PWM	Yes	Yes	↓
DCNHR300MFA	300	450	900	BOTTOM	9-36	PWM	Yes	No	↓
DCNHR300NFA	300	450	900	BOTTOM	9-36	PWM	No	No	↓
DCNHR300PFA	300	450	900	BOTTOM	9-36	PWM	No	Yes	↓
DCNHR300QFA	300	450	900	BOTTOM	9-36	PWM	Yes	Yes	↓

* For main contacts terminals with internal thread, add '-01' to suffix of part number

DCNHR Series

900V DC Max Contactor Relays

Performance Data

MAIN CONTACT		
Contact Arrangement	SPST NO	
Max Short Circuit Current	DCNHR20PF12, DCNHR20PF24 DCNHR20PF48	100A @ 450V DC
	DCNHR30PF12, DCNHR30PF24 DCNHR30PF48	150A @ 450V DC
	DCNHR40PF12, DCNHR40PF24 DCNHR40PF48, DCNHR50PF12 DCNHR50PF24, DCNHR50PF48 DCNHR50QF12, DCNHR50QF24 DCNHR50QF48	200A @ 450V DC
	DCNHR100PF12, DCNHR100PF24 DCNHR100PF48, DCNHR100QF12 DCNHR100QF24, DCNHR100QF48	400A @ 450V DC
	DCNHR150MFA, DCNHR150NFA DCNHR150PFA, DCNHR150QFA DCNHR200MFA, DCNHR200NFA DCNHR200PFA, DCNHR200QFA DCNHR250MFA, DCNHR250NFA DCNHR250PFA, DCNHR250QFA DCNHR300MFA, DCNHR300NFA DCNHR300PFA, DCNHR300QFA	2000A @ 320V DC
Dielectric Withstand Voltage	2200V AC	
Insulation Resistance	≥ 100MΩ @ 500V DC	

COIL DATA					
Voltage Rating (V DC)		12	24	48	9-36
Pickup Voltage @ 25°C (V DC MAX)	DCNHR20, DCNHR30 DCNHR40	9	18	36	/
	DCNHR50, DCNHR100	8.4	16.8	33.6	/
	DCNHR150, DCNHR200 DCNHR250, DCNHR300	/	/	/	9
Dropout Voltage @ 25°C (V DC MIN)	DCNHR20, DCNHR30 DCNHR40	1	2	4	/
	DCNHR50, DCNHR100	1	2	4	/
	DCNHR150, DCNHR200 DCNHR250, DCNHR300	/	/	/	6
Hold Current (A)	DCNHR20, DCNHR30 DCNHR40	0.3	0.15	0.073	/
	DCNHR50, DCNHR100	0.51	0.26	0.13	/
	DCNHR150, DCNHR200 DCNHR250, DCNHR300	/	/	/	0.15@12V DC
Coil Watts @ 25°C (W)	DCNHR20, DCNHR30 DCNHR40	3.5	3.5	3.5	/
	DCNHR50, DCNHR100	6.5	6.5	6.5	/
	DCNHR150, DCNHR200 DCNHR250, DCNHR300	/	/	/	Start Up/Hold 45/3

LIFE		
Electrical Life	DCNHR20PF12, DCNHR20PF24, DCNHR20PF48	10,000
	DCNHR30PF12, DCNHR30PF24, DCNHR30PF48	7,500
	DCNHR40PF12, DCNHR40PF24, DCNHR40PF48 DCNHR50PF12, DCNHR50PF24, DCNHR50PF48 DCNHR50QF12, DCNHR50QF24, DCNHR50QF48	6,000
	DCNHR100PF12, DCNHR100PF24, DCNHR100PF48 DCNHR100QF12, DCNHR100QF24, DCNHR100QF48	3,000
	DCNHR150MFA, DCNHR150NFA, DCNHR150PFA DCNHR150QFA	5,000
	DCNHR200MFA, DCNHR200NFA, DCNHR200PFA DCNHR200QFA	2,500
	DCNHR250MFA, DCNHR250NFA, DCNHR250PFA DCNHR250QFA	1,500
	DCNHR300MFA, DCNHR300NFA, DCNHR300PFA DCNHR300QFA	600
	Mechanical Life	200,000

Note: rated at continuous current rating and system nominal voltage

OPERATE / RELEASE TIME	
Close (ms)	25
Release (ms)	12

ENVIRONMENTAL DATA		
Shock	Shock, 11ms ½ Sine, Peak, Operating 20G	
Vibration	DCNHR20, DCNHR30 DCNHR40, DCNHR50 DCNHR100	4.4G, 10-200Hz (10μs)
	DCNHR150, DCNHR200 DCNHR250, DCNHR300	Vibration, Sine, 80-2000Hz., Peak 20G
Operating Ambient Temperature	-40°C--85°C	
Weight (g)	DCNHR20, DCNHR30 DCNHR40	122.3
	DCNHR50, DCNHR100	198
	DCNHR150, DCNHR200 DCNHR250, DCNHR300	398

AUX CONTACTS	
Contact Arrangement	Normal Open
Max. Rating	2A @ 24V DC
Min. Rating	0.1A @ 5V DC
Max. Resistance	≤500mΩ

DCNHR Series

900V DC Max Contactor Relays

Estimated Make Break Chart

DCNHR20 / DCNHR30 / DCNHR40

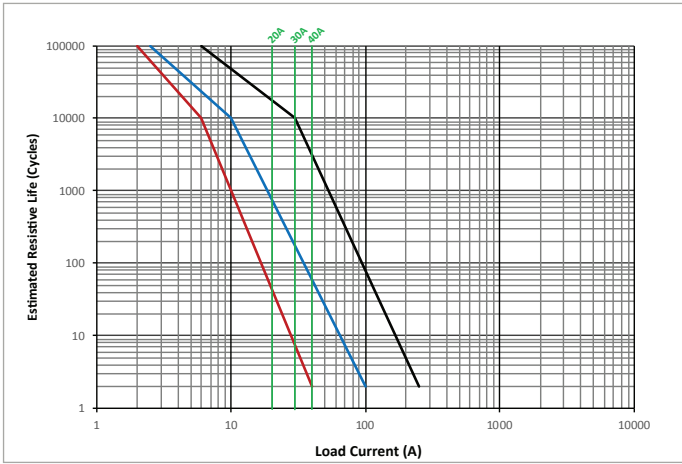

— 900V
— 750V
— 450V

Carry Current vs Time at 65°C Chart

DCNHR20 / DCNHR30 / DCNHR40

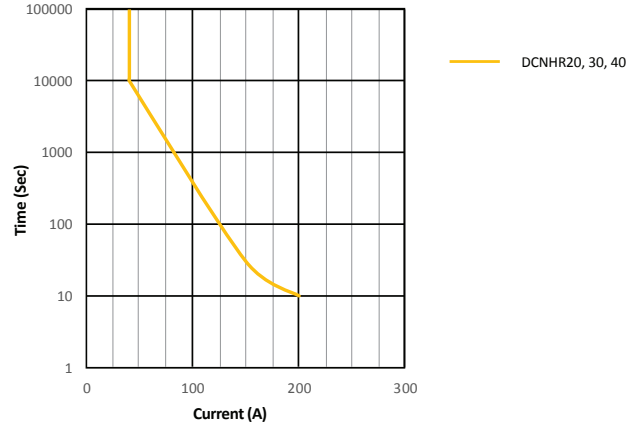

— DCNHR20, 30, 40

DCNHR50 / DCNHR100

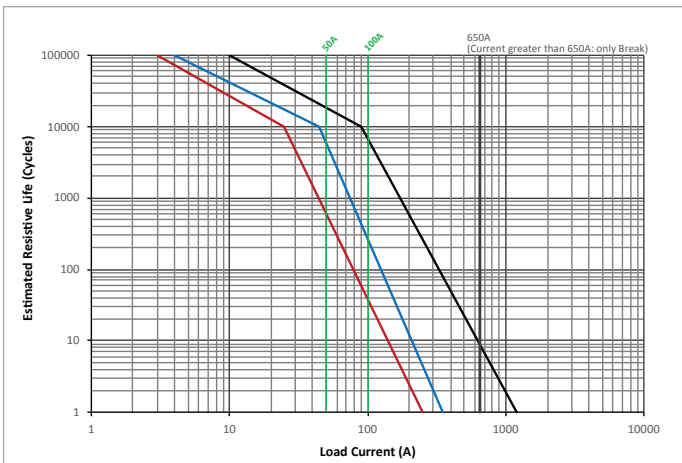

— 900V
— 750V
— 450V

DCNHR50 / DCNHR100

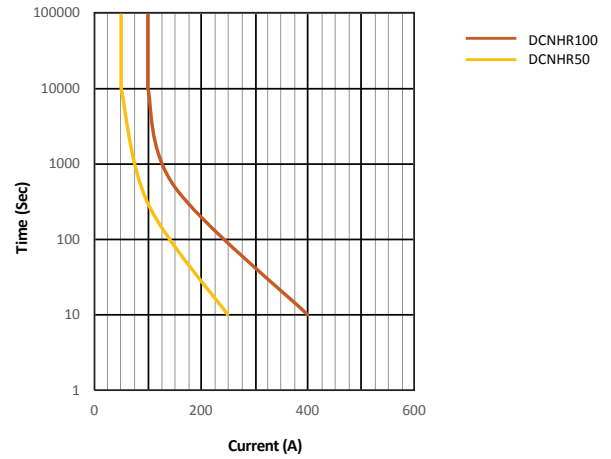

— DCNHR100
— DCNHR50

DCNHR150 / DCNHR200 / DCNHR250 / DCNHR300

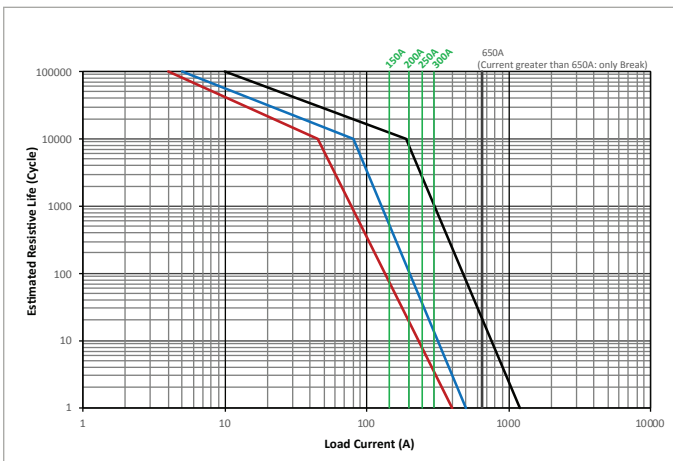

— 900V
— 750V
— 450V

DCNHR150 / DCNHR200 / DCNHR250 / DCNHR300

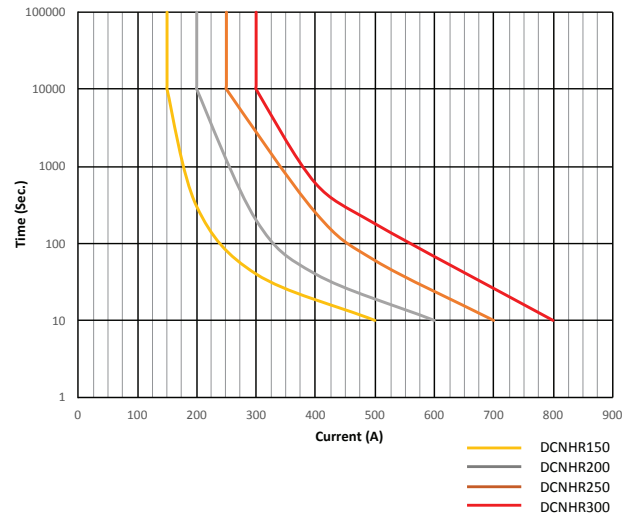

— DCNHR150
— DCNHR200
— DCNHR250
— DCNHR300

DCNHR Series

900V DC Max Contactor Relays

Part Number System

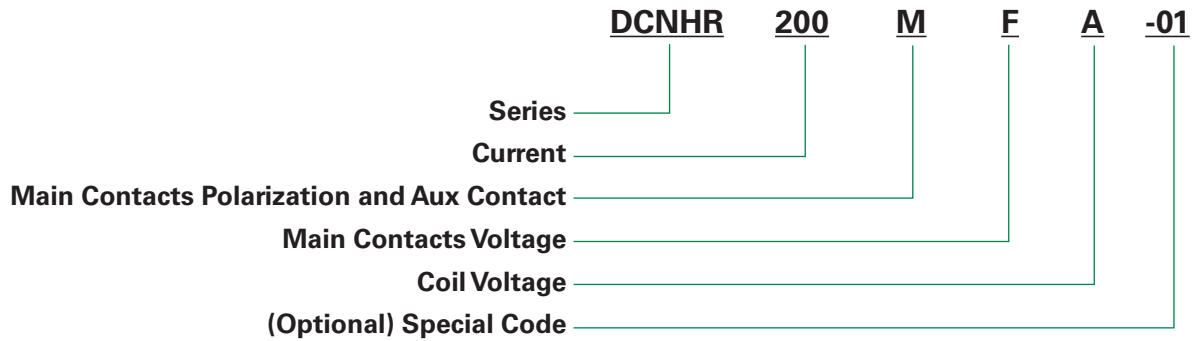

MAIN CONTACTS POLARIZATION AND AUX CONTACT		
	POLARIZED?	INCLUDE AUX CONTACT?
M:	No	Yes
N:	No	No
P:	Yes	No
Q:	Yes	Yes

MAIN CONTACT TEST VOLTAGE		
F:	450	V DC

COIL VOLTAGE		
12:	12	V DC
24:	24	V DC
48:	48	V DC
A:	9 - 36	V DC

DCNHR Series

900V DC Max Contactor Relays

Application Notes & Definitions

- Be sure to use a washer to prevent screws from loosening. Tighten the screw so that the torque is in the range specified below. Exceeding the maximum torque can lead to product rupture. See the chart below.
- Please refer to the drawing for connection polarity.
- Do not use dropped products.
- Improper assembly of a polarized contaminator can reduce life.
- Avoid installing the product in a strong magnetic field (Close to the transformer or magnet), or near an object with heat radiation.
- Electrical life
Please use under load capability and life cycle so as not to cause a function failure. (Please also treat the contactor as a product with specified life and replace it when necessary). It is possible to make parts burn around the contactor once operating failure happens. So it is necessary to take layout into account to make sure power shall be cut off within 1 second.
- Lifetime of internal gas diffusion
The contactor is sealed and filled with gas, lifetime of gas diffusion is determined by temperature in contact chamber (Ambient temperature + Temperature rising by contact energizing). Therefore environment temperature should be from -40 to +85°C.
- Do not let particle and oil stain on the main terminal with which the load shall make a reliable contact or it will cause a lot of heat.

PRODUCT SERIES	PRODUCT MODEL	CONTACT TERMINAL		COIL TERMINAL		MOUNTING	
		HOLE OR BOLT	REFERENCE TORQUE	HOLE/BOLT/WIRE/TERMINAL	REFERENCE TORQUE	REFERENCE BOLT SIZE	REFERENCE TORQUE
DCNHR20PF	DCNHR20PF12 DCNHR20PF24 DCNHR20PF48	Bolt : M5	1.7-2.0N.m	Wire: UL1332 22 AWG	/	M4	1.8-2.3N.m
	DCNHR20PF12-01 DCNHR20PF24-01 DCNHR20PF48-01	Hole : M4	1.5-1.8N.m	Wire: UL1332 22 AWG	/	M4	1.8-2.3N.m
DCNHR30PF	DCNHR30PF12 DCNHR30PF24 DCNHR30PF48	Bolt : M5	1.7-2.0N.m	Wire: UL1332 22 AWG	/	M4	1.8-2.3N.m
	DCNHR30PF12-01 DCNHR30PF24-01 DCNHR30PF48-01	Hole : M4	1.5-1.8N.m	Wire: UL1332 22 AWG	/	M4	1.8-2.3N.m
DCNHR40PF	DCNHR40PF12 DCNHR40PF24 DCNHR40PF48	Bolt : M5	1.7-2.0N.m	Wire: UL1332 22 AWG	/	M4	1.8-2.3N.m
	DCNHR40PF12-01 DCNHR40PF24-01 DCNHR40PF48-01	Hole : M4	1.5-1.8N.m	Wire: UL1332 22 AWG	/		1.8-2.3N.m
DCNHR100	DCNHR50QF12 DCNHR50QF24 DCNHR50QF48 DCNHR50PF12 DCNHR50PF24 DCNHR50PF48 DCNHR100QF12 DCNHR100QF24 DCNHR100QF48 DCNHR100PF12 DCNHR100PF24 DCNHR100PF48	Hole: M5	3-4N.m	Wire: UL1332 22 AWG	/	M4	1.7-2.5N.m
	DCNHR150PFA DCNHR150QFA DCNHR150NFA DCNHR150MFA				/		
	DCNHR200PFA DCNHR200QFA DCNHR200NFA DCNHR200MFA	Bolt : M8	8-12N.m	Wire: UL3321 22 AWG	/	M5	1.8-3.5N.m
	DCNHR250PFA DCNHR250QFA DCNHR250NFA DCNHR250MFA				/		
	DCNHR300PFA DCNHR300QFA DCNHR300NFA DCNHR300MFA				/		