



Through Hole Lamp Product Data Sheet

LTL-N709P

Spec No.: DS-20-96-0081

Effective Date: 05/31/2000

Revision: -

LITE-ON DCC

RELEASE

BNS-OD-FC001/A4

Features

- * Low power consumption.
- * General purpose leads.
- * I.C. Compatible/low current requirements.
- * Reliable and rugged

Package Dimensions

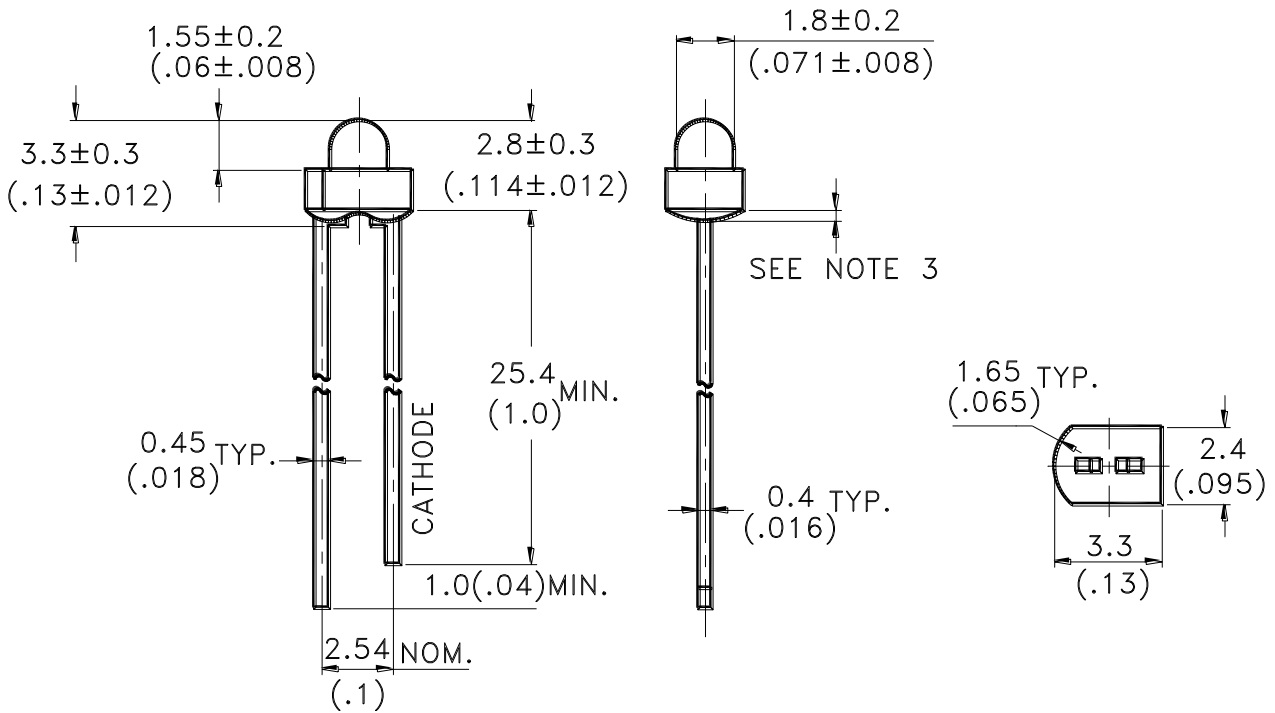

Part No.	Lens	Source Color
LTL-N709P	Red Diffused	Bright Red

Notes:

1. All dimensions are in millimeters (inches).
2. Tolerance is ± 0.25 mm (.010") unless otherwise noted.
3. Protruded resin under flange is 1.0mm (.04") max.
4. Lead spacing is measured where the leads emerge from the package.
5. Specifications are subject to change without notice.



Absolute Maximum Ratings at TA=25°C

Parameter	Maximum Rating	Unit
Power Dissipation	40	mW
Peak Forward Current (1/10 Duty Cycle, 0.1ms Pulse Width)	60	mA
Continuous Forward Current	15	mA
Derating Linear From 50°C	0.2	mA/°C
Reverse Voltage	5	V
Operating Temperature Range	-55°C to + 100°C	
Storage Temperature Range	-55°C to + 100°C	
Lead Soldering Temperature [1.6mm(.063") From Body]	260°C for 5 Seconds	

Electrical / Optical Characteristics at TA=25°C

Parameter	Symbol	Min.	Typ.	Max.	Unit	Test Condition
Luminous Intensity	I _v	1.1	3.7		mcd	I _F = 10mA Note 1,4
Viewing Angle	2θ _{1/2}		38		deg	Note 2 (Fig.6)
Peak Emission Wavelength	λ _P		697		nm	Measurement @Peak (Fig.1)
Dominant Wavelength	λ _d		657		nm	Note 3
Spectral Line Half-Width	Δλ		90		nm	
Forward Voltage	V _F		2.1	2.6	V	I _F = 20mA
Reverse Current	I _R			100	μA	V _R = 5V
Capacitance	C		55		pF	V _F = 0 , f = 1MHz

- Note: 1. Luminous intensity is measured with a light sensor and filter combination that approximates the CIE (Commission International De L'Eclairage) eye-response curve.
2. θ_{1/2} is the off-axis angle at which the luminous intensity is half the axial luminous intensity.
3. The dominant wavelength, λ_d is derived from the CIE chromaticity diagram and represents the single wavelength which defines the color of the device.
4. The I_v guarantee should be added ±15% .

Typical Electrical / Optical Characteristics Curves

(25°C Ambient Temperature Unless Otherwise Noted)

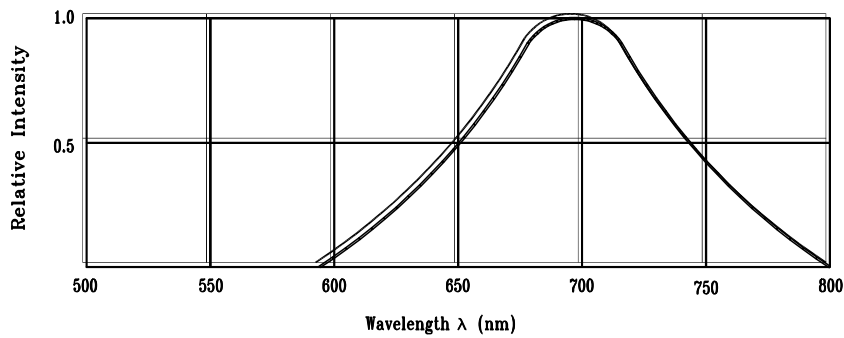

Fig.1 Relative Intensity vs. Wavelength

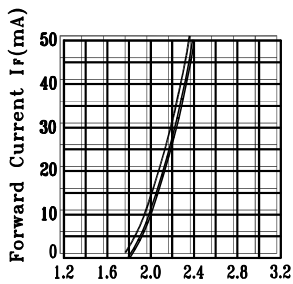

Fig.2 Forward Current vs. Forward Voltage

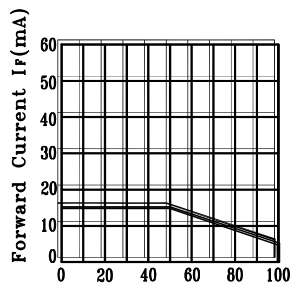

Fig.3 Forward Current Derating Curve

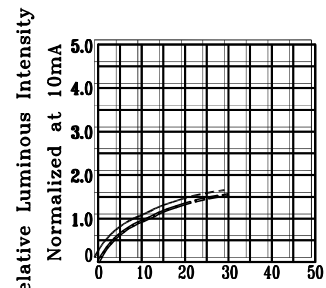

Fig.4 Relative Luminous Intensity vs. Forward Current

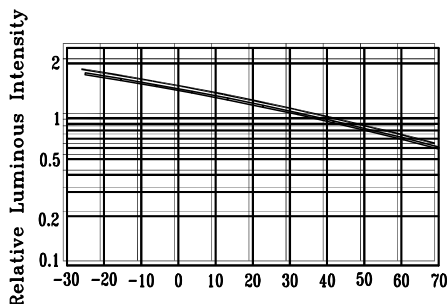

Fig.5 Luminous Intensity vs. Ambient Temperature

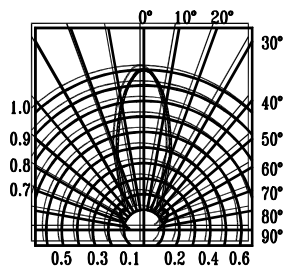

Fig.6 Spatial Distribution